



ISSUE 8

www.scolmore.com

**CONTRACTORS
BOOKLET**

Scolmore[®]
GROUP



The Scolmore Group Companies

Since our incorporation in 1989 we have become a significant force in the electrical accessory market. We're proud to be a British based, family-run business, with an excellent track record of listening to what our customers need and providing the right solution every time.



CLICK®
ScolmoreGROUP

The home of wiring accessories...

Click Scolmore® is one of the UK's leading manufacturers of electrical accessories. The company is proud to be a British-based, family-run business with an international reputation for quality, innovation and exemplary customer service.



CLICK® Litehouse

Wiring accessories & lighting Ireland...

Click® Litehouse is a joint venture operation between Litehouse Accessories Ltd and Scolmore® International Ltd.



Scolmore®
DUBAI

Wiring accessories & lighting Dubai...

Following six years of successful trading in the Middle East, Scolmore® Group opened a head office and warehouse facility in Dubai. Scolmore International Electrical Trading (Scolmore® Dubai) is located in the heart of Dubai in the Business Bay area.



OVIÀ®
ScolmoreGROUP

Lighting solutions...

Already synonymous with superior performance and innovation following eight years of success as a leading name in the lighting industry, the Ovia® brand of lighting solutions has been further developed to meet the growing opportunities that the transformed lighting industry offers.



ESP®
ScolmoreGROUP

Fire, Security & Emergency Products...

ESP® (Elite Security Products) Ltd is a market-leading supplier of a comprehensive range of electronic security and fire protection products.



ESPI®
ScolmoreGROUP

Fire, Security & Emergency Products Ireland...

ESPI® (Elite Security Products Ireland) Ltd is a market-leading supplier of a comprehensive range of electronic security and fire protection products.



OVIÀ®
ScolmoreGROUP

Lighting solutions for Ireland

Already synonymous with superior performance and innovation following eight years of success as a leading name in the lighting industry, the Ovia® brand of lighting solutions has been further developed to meet the growing opportunities that the transformed lighting industry offers.



UNICRIMP®
ScolmoreGROUP

A comprehensive range of cable accessories...

Established as a new business by the Scolmore® Group in 2015, Unicrimp® brings to the electrical contracting industry a comprehensive range of cable accessory products.



SANGAMO

Time switches & heating controls...

Founded in 1921 and proudly manufactured in the UK, Sangamo is recognised as one of the world's leading design and manufacturers of a wide range of electrical measuring and control equipment.



Find Out More...

For more information on the companies and ranges explore the following pages.

The Home Of Wiring Accessories...



Click Scolmore[®]

Click Scolmore[®] is one of the UK's leading manufacturers of electrical accessories. The company is proud to be a British-based, family-run business with an international reputation for quality, innovation and exemplary customer service.

From our head office in the Midlands, we design, develop and manufacture an ever expanding product range for distribution throughout the UK and worldwide.

The Click[®] Wiring Accessories range remains the number one choice for electricians and contractors who value the flexibility of the modular based range, as well as the one-stop solution that the comprehensive offer allows.

Our online ordering service is supported by automated order picking and processing procedures which enables us to offer service levels we believe are unprecedented in the industry.

The company is committed to harnessing the very latest technologies and developing superior-performing, competitively-priced products which allow installation projects to be completed quickly and easily.

Wiring Accessories



Aquip66[®]



Click Smart+

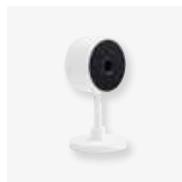

Elucian[®]



Essentials[™]



MODE®

CLICK®
ScolmoreGROUP

CMA812



CMA735



Mode® Made Easy

A stylish, contemporary and flexible range of smooth profile wiring accessories

The smooth, modern lines of the Mode® accessory plate will fit easily into traditional and contemporary designs alike. Mode® accessories provide flexibility with a comprehensive selection of products ranging from a standard light switch and socket outlet through to more specialised products dealing

with the very latest developments in entertainment media interfaces.

We've shown just a sample of the Mode® range. To see the full range or for more details, please log onto www.scolmore.com and register for your free wiring accessories catalogue, or download the Mode® section.

www.scolmore.com

Email: contractor@scolmore.com

Easy Installation...

with earth terminals at the top of the product.

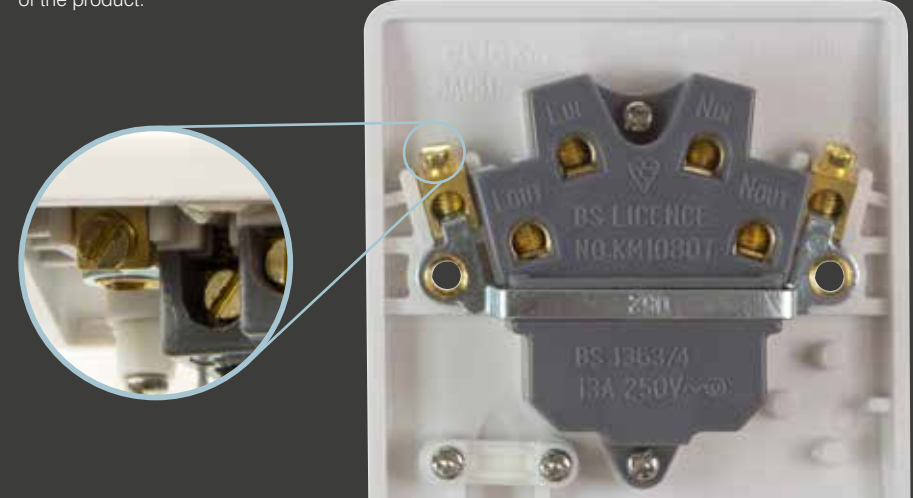

Interchangeable Modules

Mode® accessories have been designed with the electrician in mind, by designing our products with earth terminals at the top of the product for easy installation.

Mode® accessories have been conceived and developed as a high quality, flexible & modern solution to virtually any domestic wiring requirement.

Simple, single screw fixing of modules offer the simplest possible means of installing and replacing modules.

The modular design of Mode® allows designers and installers unprecedented flexibility in creating dedicated wiring solutions to deal specifically with actual wiring needs.

Antiviral & Antibacterial Certified

Mode® wiring accessories are manufactured using Urea Formaldehyde, which has similar inherent properties to antimicrobial additives that inhibit the growth of infectious diseases. All products independently tested achieved a 99.99% kill off rate across all four types of the strains of bacteria - MRSA, E-Coli, Salmonella, Klebsiella Pneumoniae and enveloped viruses.



Call: 01827 63454



Keeping **US** Boosted

1 and 2 gang switched sockets with USB

Eliminate the need for bulky chargers and free up your plug sockets with 1 and 2 gang switched socket with integrated USB! Our 1 and 2 gang switched sockets with dual USB outlets are available in 98 plate designs and finishes within the Click® brands. This provides flexibility for use in various

locations; i.e. lounges, kitchens, bedrooms and offices.

Mode®, Polar™, Deco® and Deco Plus® require 25mm back boxes.

1 and 2 gang Define® and Definity™ require 35mm back boxes, while our Metal Clad range come supplied with 40mm back boxes.

Available in 98 Plate Designs...

with black or white inserts.



USB Output 5 volt 2 amps

Suitable for most tablets, smart phones, cameras and other USB devices, all of which can still be used whilst charging! Twice as fast charging - Charge two devices simultaneously without fear of fluctuations within the power supply interfering! The load isn't split across both ports on our USB sockets, so you are guaranteed optimum charge every time!

Safety

Tested and complies with UK safety and EMC requirements and is in-line with EU legislation. The USB socket ranges also benefit from short circuit protection, so should there be a short on the output the power supply will shut down and reset after the short circuit has been removed.

Twin Earth Terminals

For a simple connection of the earth conductor.

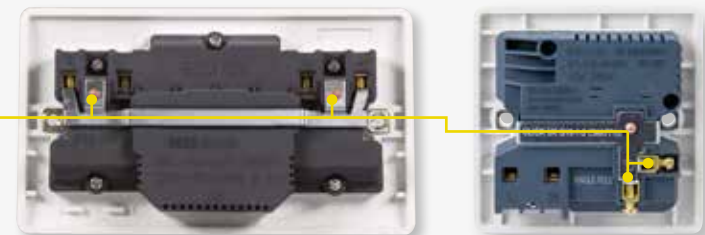



Ease of installation is hard-wired into our thinking

The Polar™ range of domestic electrical accessories has been developed as a distinctly different range to the traditional Click® accessory range manufactured by Scolmore® International Ltd. The Polar™ range was born out of a desire to offer a bright white wiring accessory

product. Colour choice with wiring accessories is no different to colour choice of wallpaper, paints or other internal decorations. Installers have very definite views on which tone or shade of white is right for a particular installation.

Can be utilised with a 25mm deep back box if required...

UK Design Registration No. 3015175



45A Max Dual Connection Plate and Pattress Box

Product references: PRW218 and PRW217

- Each incoming and outgoing cable wired independently, making installation easier
- Accepts up to 3 x 16mm² twin and earth with 45A maximum loading
- Dedicated 35mm deep pattress box



PRW218
Pattress box for PRW217



PRW217
45A max dual connection plate

Antibacterial & Antiviral Certified

Polar™ wiring accessories are manufactured using Urea Formaldehyde, which has similar inherent properties to antimicrobial additives that inhibit the growth of infectious diseases. All products independently tested achieved a 99.99% kill off rate across all four types of the strains of bacteria - MRSA, E-Coli, Salmonella, Klebsiella Pneumoniae and enveloped viruses.



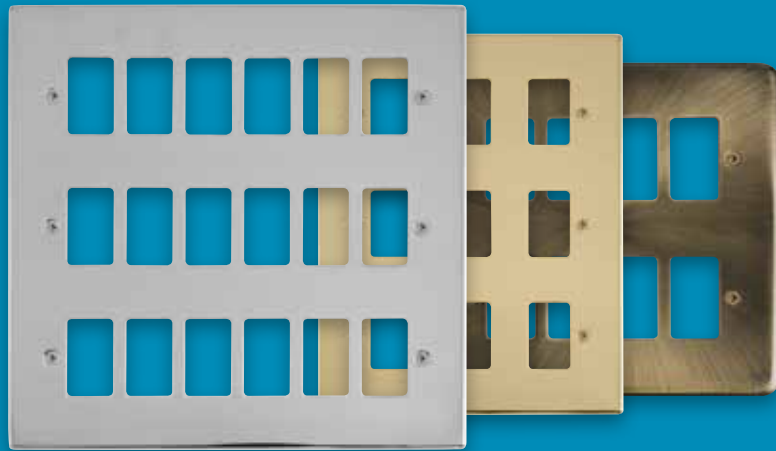

GridPro® puts you in Pole Position

A versatile range of 20A grid products

A comprehensive range of finishes and modules available to offer ultimate flexibility. As well as a wide range of modules to choose from all of our switch modules are 20A/20AX rated so they are ideal for both domestic and commercial applications.

The GridPro® range will complement your existing Click® installation, as the range was specifically designed to seamlessly match our existing ranges of Click® wiring accessories.

Ergonomic Modules

GridPro® features design elements that enable quicker and easier installation whilst maintaining all the key features and stylish design of the existing range of Click® wiring accessories.

All modules come with backed off captivated terminal screws for ease of assembly.

A screwdriver guide ensures the screwdriver easily locates with terminal screw head to clamp the cable in position. The terminal screw apertures are designed to help guide the tool.

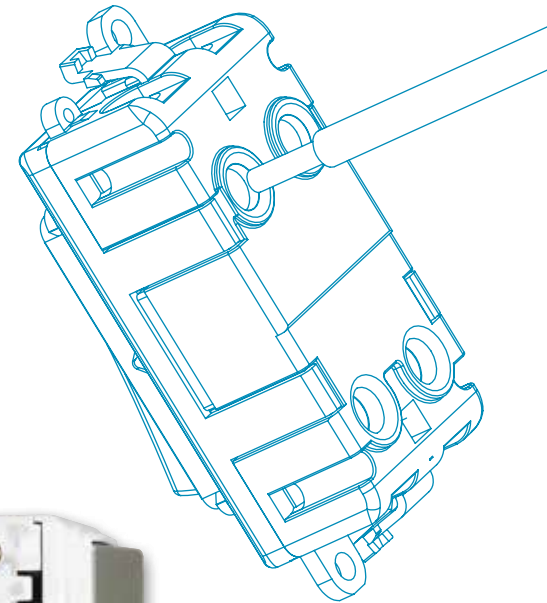

New Grey Modules...

All Grid Pro modules have a clipping and screw attachment on each module.



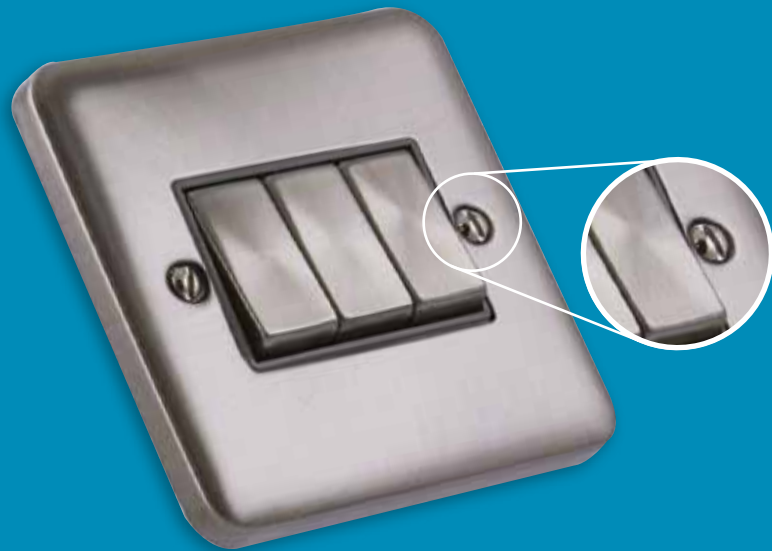

Horizontal Fixing Screws

GridPro® frontplates have horizontal mounted screws to give a uniform, aesthetic look throughout the range.

For use with 1-4 gang GridPro® frontplates...



*excluding the screwless Definity™ GridPro® frontplates, which have their own dedicated inserts.

No Yoke!

The GridPro® modules are secured to the back of the 1-4 gang GridPro® frontplates via the screw feature on the modules*. The benefit of not using a yoke is that it allows the installer to use standard back boxes!



No Yoke!

Screw directly on to the back of 1-4 gang GridPro® frontplates!

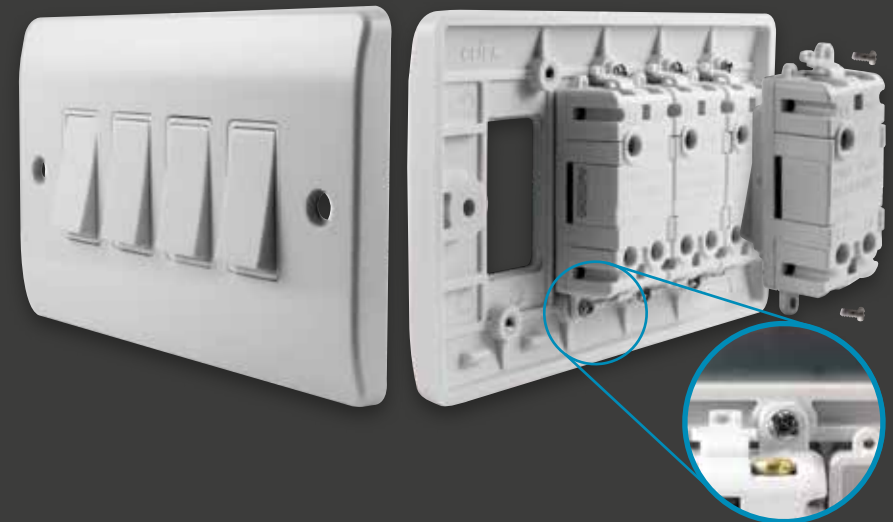

Standard BS4662 Back Boxes

A unique feature of 1-4 gang GridPro® frontplates is that any British Standard BS4662 flush mounted back boxes can be used. This is because our 1-4 gang GridPro® frontplates do not require a yoke!*

*excluding the screwless Definity™ GridPro® frontplates, which have their own dedicated inserts.



GRIDPRO®

CLICK®
ScolmoreGROUP

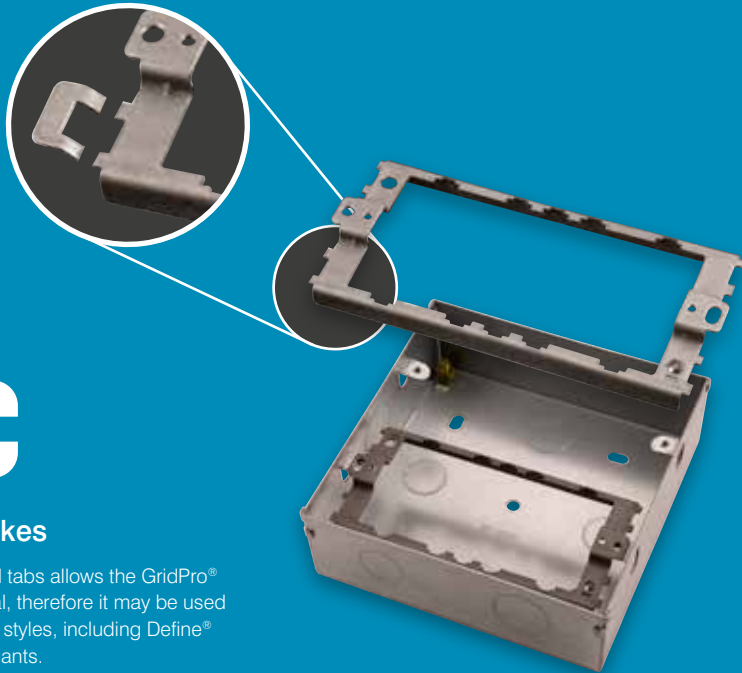

Universal Yokes

Removal of the end tabs allows the GridPro® yoke to be universal, therefore it may be used for any Click® plate styles, including Define® and Metal Clad variants.

*excluding the Definity™ GridPro® frontplates, which have their own dedicated inserts.



In house laser etching on all our GridPro® modules!

Laser Etching

Let us save you time and money and do the module etching for you! Completely customisable modules, offering you and your customers a wider variety of options.

Contact us for more information.



Clip-on Modules

When a yoke is required on the multi-tier GridPro® frontplates, the module can be assembled using the clip attachment which secures them to the metal yokes.

For use with 6-24 gang GridPro® frontplates*

*excluding the screwless Definity™ GridPro® frontplates, which have their own dedicated inserts.



All GridPro® modules are available in twelve distinctive, quality finishes, with black or white inserts. Antique brass, black nickel and matt black finishes are available with black inserts only. Brushed stainless, satin chrome and stainless steel finishes are available with grey inserts.

Module finishes available: Matt Black (MB), Antique Brass (AB), Black Nickel (BN), Pearl Nickel (PN), Polished Brass (BR), Polished Chrome (CH), Satin Brass (SB), Satin Chrome (SC), Brushed Stainless (BS), Stainless Steel (SS), Black (BK), Polar™ White (PW) and Red (RD).



Overload Protection for Ventilation Equipment

It has been noted that some manufacturers of ventilation equipment (fans) are not installing internal fuses to protect the equipment. Instead the manufacturers are stating within their installation literature the fan requires overload protection via a 1, 3 or 5 amp fuse.

Regulation 134.1.1 of BS 7671:2018 incorporates amendment No 1:2011 and does require electrical equipment to be installed in accordance with the instructions provided by the manufacturers of the equipment.



Module finishes available: Matt Black (MB), Antique Brass (AB), Black Nickel (BN), Pearl Nickel (PN), Polished Brass (BR), Polished Chrome (CH), Satin Brass (SB), Satin Chrome (SC), Brushed Stainless (BS), Stainless Steel (SS), Black (BK), Polar™ White (PW) and Click® White (WH).

As standard across our moulded and decorative ranges we offer a 10A 3 pole fan isolation switch and a fused connection unit module all in one switch plate. Saving you valuable time and money!

Simple, single screw installation of the modules on the plate allows contractors to devise and install customised switching solutions on site.



Lockable fan isolation module options available.

CMA403

MD020PW

MD047PW

Simple Single Screw Installation...

Above plate available pre-assembled - **CMA3020**



The Brightest Dimmer you can Fit

You'd expect bright ideas from Click®, simply because we talk to contractors. Your problems are our challenges. Our MiniGrid® dimmer module mounting kit fits all MiniGrid® plates, and its nut runner makes installation a breeze.

The dimmer module mounting kit comprise a module mount frame, operating knob and innovative nut runner to facilitate the fixing

of the locking nut. Locking nut and washer supplied with the Click® dimmer modules.

- Nut runner means it's easy to fit the locking nut and quick to install (supplied)
- Fits the Click® wiring accessory ranges
- Wide range of wattages available (400W max)

Select your plate and modules...

then assemble.



Plate finishes available:

Antique Brass (AB)	Satin Brass (SB)	Also available:
Black Nickel (BN)	Satin Chrome (SC)	Black (BK)
Brass (BR)	Stainless Steel (SS)	Polar™ White (PW)
Chrome (CH)	Brushed Stainless (BS)	Click® White (WH)
Pearl Nickel (PN)	Georgian Cast Brass (GCBR)	Matt Black (MB)

Interchangeable dimmer switch modules:

MD9010	1-10V analogue dimmer module (25 x 62 x 22mm)
MD9001	6A 2 way push on/off (non-dimmable) module (25 x 62 x 22mm)
MD9022	250W/Va 2 way resistive/inductive dimmer module (25 x 62 x 22mm)
MD9042	400W/Va 2 way resistive/inductive dimmer module (25 x 62 x 22mm)
MD9014	100W Dual Mode Dimmer Module with Trim (25 x 57.5 x 24.2mm)



MD150CH

Module mounting kit in polished chrome finish. Dimmer module not supplied.

We have shown just a sample of the MiniGrid® range. To see the full range or for more information please visit www.scolmore.com. Register for your free wiring accessories catalogue, or download the MiniGrid® section.



Eliminate Flickering

Trim the brightness easily with the DIP switch.



Easy to Program

Never loses your installation settings.



Two Dimmers in One

Simply change between leading and trailing edge with DIP switch.



The only Dimmer you'll ever need

Suitable for dimming on a conventional 2 way circuit, our new 100W Dual Mode Dimmer with trim function is much easier to program than regular dimmers because of the two small switches on the back of the module. This allows the dimmer to be programmed without removing from the plate.

Small Module Size...

fits into MiniGrid® and GridPro® mounting kits.

- Can be placed above/below each other on multi-tier plates.
- Will fit into 25mm back box when used on raised plates.
- Will fit into 35mm back box when used on flat plates.
- Interchangeable with the MD9022 and MD9042 in our dimmer plates.



Thermal Overload Protection

If the module gets too hot it will cut out without damaging the internal electronics, allowing the module to cool down. This will not reset installation settings.

Leading or Trailing Edge

The installer has the option to select the most effective mode for the situation and lamps being used. This also allows for maximum compatibility.



MD9014

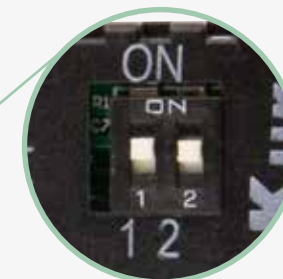

- 1 Switch 1:** Allows the minimum brightness to be adjusted
- 2 Switch 2:** Allows the dimming mode to be adjusted



Flexibility of Range Comes as Standard

All Click® plates are modular as standard, 850 modules in stock with millions of combinations.

Every installation's different - but they've got a lot in common - like the components of the mains wiring. MiniGrid® modules make it easy to configure and install accessories - saving you valuable time and money.

- The 12 and 18 gang cover plates offer up to 18 different switching functions within a single plate.
- 17 printed legends available as standard on double pole switches
- Over 175 unfurnished plates available
- Offers simplicity in its single screw fixing

Tailor to your needs...

with easy and quick to install, simple screw fixing modules.



Module finishes available: Matt Black (MB), Antique Brass (AB), Black Nickel (BN), Pearl Nickel (PN), Polished Brass (BR), Polished Chrome (CH), Satin Brass (SB), Satin Chrome (SC), Brushed Stainless (BS), Stainless Steel (SS), Black (BK), Polar™ White (PW) and Click® White (WH).

We have shown just a sample of the MiniGrid® range. To see the full range or for more information please visit www.scolmore.com. Register for your free wiring accessories catalogue, or download the MiniGrid® section.

Interchangeable modules:

MD023	20A Double Pole Switch with Neon Module
MD046	13A Double Pole Key Switch Module
MD020	10A 3 Pole Fan Isolation Switch Module
MD029	10AX Double Pole Key Switch Module
MD220	10A 3 Pole Lockable Fan Switch Module

PRW618



CMA612



Antibacterial & Antiviral certified products...

perfect for commercial applications

Mode's Extended Family

Latest additions to the comprehensive Mode® range of accessories are the 12 and 18 gang plates. Utilising the plates and the MiniGrid® modules allows contractors to devise and install customised switching solutions on-site.

Antibacterial & Antiviral Certified Products

All white moulded and Mode® Part M™ wiring accessories are manufactured using Urea Formaldehyde, which has similar inherent properties to antimicrobial additives that inhibit the growth of infectious diseases. All products independently tested achieved a 99.99% kill off rate across all four types of the strains of bacteria - MRSA, E-Coli, Salmonella, Klebsiella Pneumoniae and enveloped viruses.

MiniGrid® just got Tougher

CL518



The 12 & 18 gang Metal Clad switch plates offer versatility & strengthen the comprehensive selection of Metal Clad products that are already available. Electrophoretically coated plates and back boxes provide a durable and long lasting heavy duty finish to this attractive range of products.

All switch products are of modular construction allowing the installer total freedom in designing customised switching solutions.

*50mm Deep 12 and 18 gang metal clad back boxes are available, providing additional space to accommodate the necessary wiring.

Also available:

1 and 2 gang 13A DP Metal Clad switched socket with outboard neon rockers. Unfurnished plates and mounting boxes are available for use in conjunction with our extensive range of MiniGrid® and New Media™ modules.



CL835



CL840



Switching to us is Key

Hotel key card switches

Our key card switch acts as the main electrical switch for the room and is operated by the guests', reducing the amount of time the lights (and/or appliances) are left on. All lighting and heating facilities only become operational once a corresponding card is inserted into the key card switch, so no needless heating, cooling or lighting of an unoccupied space takes place.

When the key card is removed the controlled circuits remain under power for a further 10 seconds to 5 minutes, which can be adjusted by the hidden potentiometer under the cover plate. This helps ensure a safe exit from the room before the power is turned off.

Compatible with hotels' entry system cards. Suitable for standard cards and credit cards 85.6mm x 53.98mm.

The hotel key card switch comprises of 3 separate products. Providing versatility to compliment any decor or existing Click® wiring installations, with interchangeable mounting and cover plates.



1. Mounting plate
2. Key card timer switch module
3. Finishes to complement all Click® decorative and white moulded ranges

Controlling Lighting Circuits

Suitable for switching inductive loads of 6AX and resistive loads of 10A. Larger loads such as sockets and air conditioning can be connected via contactors. Connection terminals suitable for 2 x 1.5mm² cable.



GridPro® Illuminated Modules

250V transparent illuminated blank modules are available in red; blue or green illumination.

- 1 and 2 way switches illuminate when the switch is in the OFF position.
- Double pole switches illuminate when the switch is in the ON position.

Finishes available

(Red & Green Switch Locator Module):

Antique Brass (**AB**), Black Nickel (**BN**), Pearl Nickel (**PN**), Polished Brass (**BR**), Polished Chrome (**CH**), Satin Brass (**SB**), Satin Chrome (**SC**), Brushed Stainless (**BS**), Stainless Steel (**SS**), Black (**BK**), Polar™ White (**PW**).

New Media™ Touch Module

Located within the hotel room for the occupier to interact with, thus illuminating the corresponding Indicator Module located outside the room, making staff aware of the room requirements. Black and White Finish options available.

MP606CHBK

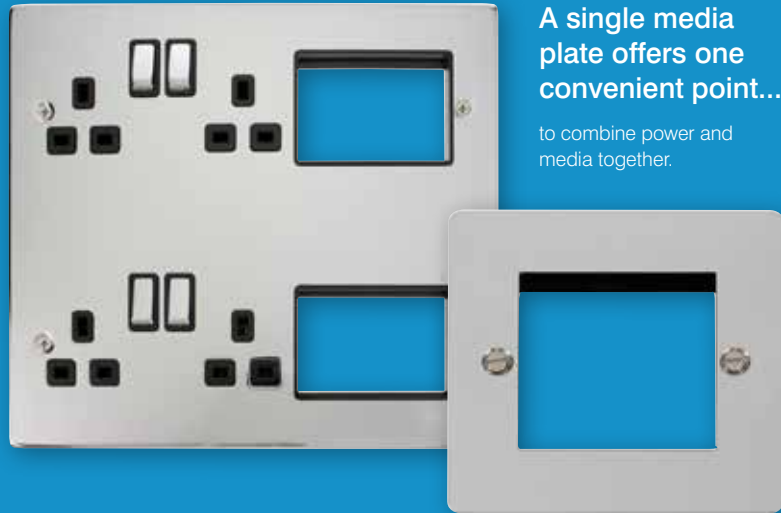

A single media plate offers one convenient point...

to combine power and media together.

FPCH311

The Power of Media

New Media™ plates and modules

The modern home is now more than a mere home. It doubles up occasionally as a cinema, concert hall, meeting

venue and computer room etc. and New Media™ wiring accessories are perfect.

10AX/13A rocker switch modules

MM002BK	10AX 2 way switch - black
MM002WH	10AX 2 way switch - white
MM025BK	10AX intermediate switch - black
MM025WH	10AX intermediate switch - white

20A double pole rocker switch modules

MM022BK	20A DP switch - black
MM022WH	20A DP switch - white
MM023BK	20A DP switch with neon - black
MM023WH	20A DP switch with neon - white

MP606 and MP603 are perfect for your satellite installation...



Required modules:

MM406*	Double satellite
MM501*	HDMI outlet with flexible connection (80mm long)
MM415*	Single male IEC (FM)
MM410*	Single female IEC (TV)
MM460*	Telephone master

New Grey New Media™ Modules



New Mode® Lounge Combination Plates

CMA606

2 x 13A Switched Sockets and 2 x 3 Euro Module spaces.

CMA603

1 x 13A Switched Socket and 1 x 3 Euro Module spaces.



Whatever the Weather

IP66 Weatherproof Wiring Accessories

The IP66 rated weatherproof socket and switch enclosures offer users a single fix installation - with the whole of the back box fixing to the wall to accommodate

the socket or modules. Multiple knock-outs on each side (20mm) allow for entry from all angles, and more...



New Transparent Covers!

- Polycarbonate construction
- Flexible rubber base allows for mounting on most types of uneven surfaces
- UV protected against fading
- Smooth operation of switches
- Neutral modern design suitable for most locations
- High impact resistance
- Ergonomic design



New and Improved Design

- Lid is now designed to stay open to aid installation.

Multiple Gland Entry Position

- 20mm knock-outs for entry from all angles

Multiple Switch Configurations

- Designed to fit MiniGrid® / GridPro® modules.

Weatherproof - IP66

- Protection against ingress of water jets and dust

MINIGRID®



GRIDPRO®



The Aquip66® range uses the MiniGrid® (13A Max) or the GridPro® (20A Max) system's interchangeable switch modules, allowing multiple switch configurations.



Making your home smarter

Communicate and connect with your home - anywhere

Can you imagine how your home could integrate itself into your daily life? Click Smart+, Scolmore's leading smart home brand, has been created to simplify and streamline your home life via the use of integrated technology.

Click Smart+ boasts an elite range of smart home products. Utilising Zigbee

technology & WIFI to offer smart home solutions to new and existing wiring installations.

The possibilities of Click Smart+ are endless, but the set up – whether with WIFI or with Zigbee – is simple when using our Click Smart+ app.

'Tap to Run' Smart Scenes

Tap-to-run also known as 'Scenes' enables you to run multiple devices with a single tap of a button (within the Click Smart+ app). Think of this as one switch for a group of products.

To control your Click Smart+ products through voice control you must have an Amazon Alexa speaker or a Google Home Speaker set up in your home and connected to the Click Smart+ app.



'Automation' Smart Scenes

Automations control your devices automatically when a condition is changed. Automations also allow you to set up timing Schedules for a group or singular smart products.

To control your Click Smart+ products through voice control you must have an Amazon Alexa speaker or a Google Home Speaker set up in your home and connected to the Click Smart+ app.



Smart Power

Control your home anywhere, anytime. A choice of a 1 or 2 gang smart sockets. Allowing you to control the power to each outlet with a smart device or voice control.



Smart Security

Peace of mind away from home with our smart security products. 1080p smart camera, wireless PIR sensor, temperature and window/door sensor.



Smart Receivers

Click Smart+ receivers control your lights and appliances from wherever you are. Simply fit to existing switches or directly at the light source.

Smart Sockets



With the smart socket you can plug in home appliances like lamps, TVs, heaters, fans etc. Simply turn them on or off with your voice, smart device with the Click Smart+ App or with an automation, timer or schedule.



Wireless Smart Switch

Click Smart+ GridPro® Modules

The Smart GridPro Scenario Switch is a wireless switching solution. It can work in conjunction with other ClickSmart+ devices to design and implement smart application scenarios.

Available in white and black finishes.

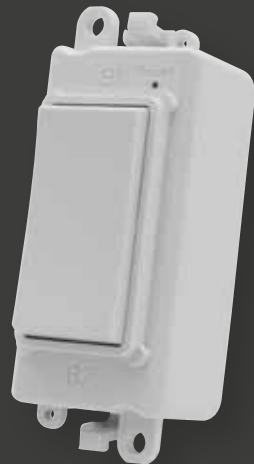

www.click-smart.com

Email: contractor@scolmore.com

The Smart LED Tape Controller



Get Creative

Choose between 3 modes, White, RBG and Music Mode!

Connect the Smart Controller to your LED Tape and control them in every room by voice or app.



White

Control the brightness of your LED Tape and create the perfect atmosphere for your home.



Colour (RGB)

Choose any colour to suit your mood along with the brightness and saturation.

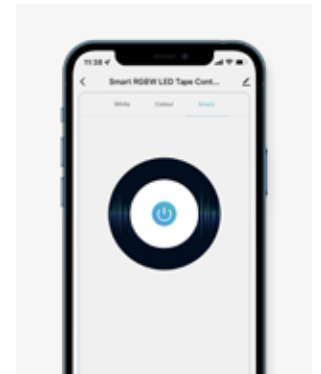

Music

With the Click Smart+ app open and set to 'Music' the LED tape will change colour with the music.

Smart Fused Connection Unit

FCU Gasket

The gasket comes supplied with the Fused Connection Unit, which features an optional cable outlet.



Call: 01827 63454



Keeping you in charge

Elucian by Click® the complete consumer unit range

Following months of extensive research and consultation with contractors and installers, we developed a range of products that best suits their requirements and that are compliant with all the latest regulations. Designed with the installer

in mind, Elucian is an extensive range of metal consumer units that will cover a broad range of installations and offers a number of features and benefits that will enhance the products' convenience, flexibility and safety properties.



Switch-Disconnecter Units Including Surge Protection

A range of Elucian Metal Consumer Units furnished with a 100A Mains Switch and a 2 Pole Type 2 275Uc (V~) 40kA SPD.



Split Load Units Including Surge Protection

A range of Elucian Metal Consumer Units furnished with a 100A Mains Switch, 2 x 80A Type A RCDs and a 2 Pole Type 2 275Uc (V~) 40kA SPD.



Combination Units (High Integrity) Including Surge Protection

A range of High Integrity Elucian Metal Consumer Units furnished with a 100A Mains Switch, 2 x 80A Type A RCDs and a 2 Pole Type 2 275Uc (V~) 40kA SPD.



Mini Units (Garage)

A range of Elucian Metal Consumer Units ideal for garage installations. Furnished with either a 63A or 80A Type A RCD.

Protective Devices

Our Elucian range of Protective Devices are easy to install, suitable for residential and light commercial environments, they provide protection against earth faults to ensure people's safety against electrocution and fires.



3 Year Warranty



Clip in Devices



Lock Off Capabilities



RCBO

1 Pole + Neutral True 6kA B Curve & C Curve 30mA Trip RCBOs



Contactors NO / NC

20A, 25A, 40A or 63A Modular Contactors



AFDD & RCBO

1 Pole + Switched Neutral True 6kA B & C Curve AFDD & RCBO



RCDs

2 Pole 30mA Residual Current Device



MCBs Single Pole C Curve

1 Pole, True 6kA B Curve & C Curve MCB Devices



SPDs

1 Module 2 Pole 40kA Surge Protection Device



Mains Switch-Disconnecter

2 Pole 100A Mains Isolator Switch



Fused Main Switch

80A & 100A Fused Main Switches



Blank Modules

Single way Din Rail Blank Module

WA4235

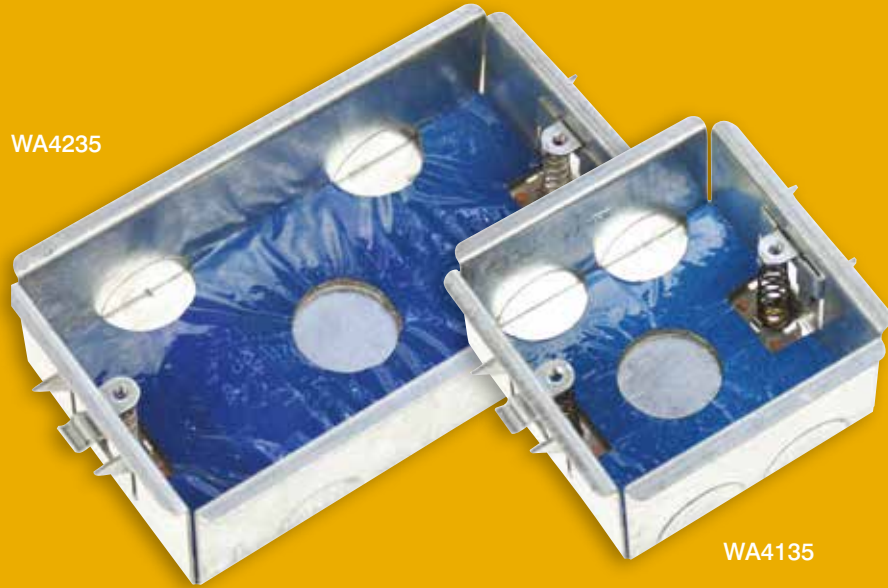

WA4135

FlameGuard® Back Boxes

Fire and acoustic rated metal dry lining back boxes

The FlameGuard® intumescent seal, when exposed to fire, forms a dense carbon char which separates and insulates the substrate from the heat of the fire. The expanded seal eliminates the flow of air through the void and thereby starves the fire of vital elements for combustion.

Building Regulations are becoming more stringent in today's modern world, with alternative building materials and products being developed with improved safety in mind.

FlameGuard® Back Boxes...

- No additional components to purchase or install
- Simple and quick to install saving time and money
- Multiple cable entry points available
- Earth terminal fitted
- Durable all steel construction
- Unique spring loaded lugs

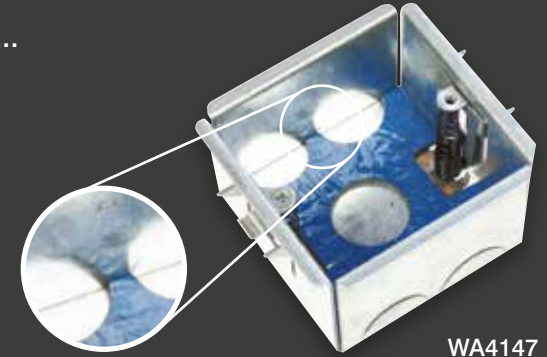

WA4147

New and Improved Features*

*WA4247 and WA4147 only

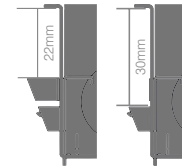

- Upper tabs work from 5mm to 22mm
- With the upper tabs removed, the lower tabs work from 15mm to 30mm



- Now with second pair of gripping arms
- Maximum board thickness of 30mm
- Arms are designed to easily break off with pliers

WA4247



WA4235

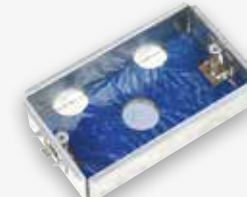

WA4135



FlameGuard® back boxes have been tested and conform to both fire and acoustic standards BS EN 1364-1:2015, BS EN ISO 10140-2: 2010. Complies with Building Regulations. Fire tested up to 90 minutes with the capability of the boxes being mounted back to back.



Working Side by Side

The 1+2 dual accessory galvanised steel back boxes (WA370 and WA375) have been designed to allow all Deco®

and Deco Plus® products to be fitted side by side with the supplied gaskets.

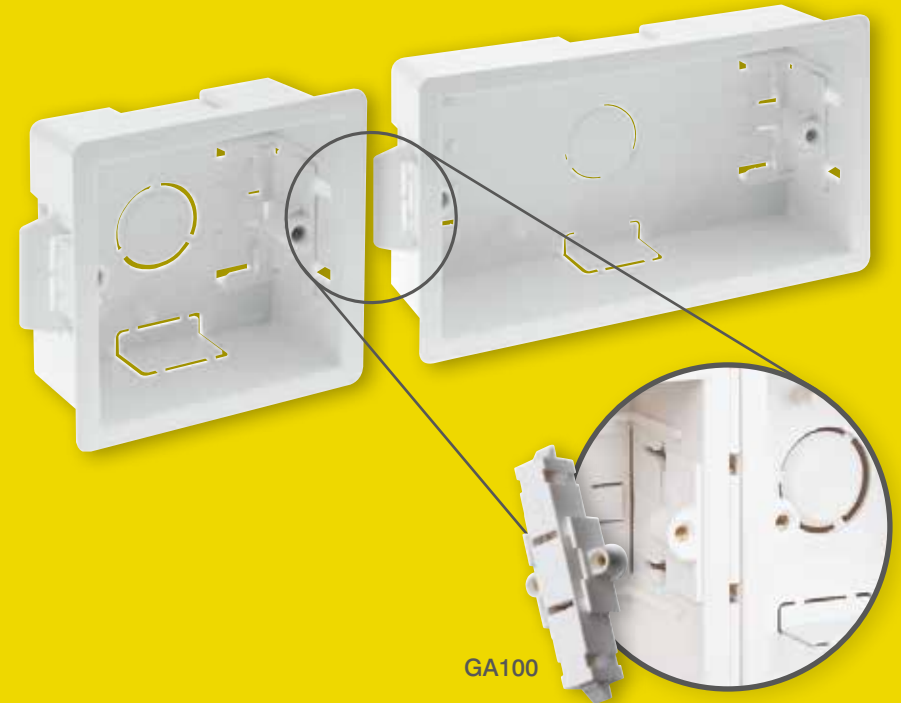

Click together with the Click® Connector

Ezylink (GA100) dry lining wall box connector simply connects most combinations* of Click® dry lining boxes to provide the neatest installation of cavity boxes possible.

*Ezylink **IS** compatible with:
WA087P / 088P / 106P / 107P

*Ezylink **IS NOT** suitable for use with WA108P

Click® Website

The Click® website showcases the full range of quality, cost-effective products currently on offer. With regular updates on new products, as well as details of developments within our business.

Having recently updated the site to include links to product and service specific micro sites, we aim to give you access to new information in a timely fashion. You can access these sites via links on the main site or by connecting directly. Either way you can be sure you will always have the latest information at your fingertips.

Online Ordering

The site now incorporates a number of improved features that allow users to access new information directly and easily:

- Ordering 24 hours a day 7 days a week with the ability to check current stock levels as required, meaning you are not restricted to ordering during normal office hours.
- Access to on-line catalogues will keep you fully updated with the complete product range and provide information on new products as and when they become available.
- The order tracking service keeps you up to date with the progress of your shipment.
- Managing your administration paperwork is now even easier with instant access to reports and essential documents at a click of a button.
- A 'quick buy tab' and the ability to store the most common orders for repeated use, adds to the versatility and flexibility of the revised system.
- PDF purchase order uploads now available. You can now take your purchase order directly in PDF format and upload it to automatically extract the data and validate its contents.

www.scolmore.com



Click Scolmore® Product Finder

The Click Scolmore® product finder tool makes it easier than ever for electricians, wholesalers and end users to search and locate products from across all categories, with just a few clicks.



To Register: E-mail us at sales@scolmore.com or call our Sales Office on **01827 63454** and one of our Sales Representatives will be more than happy to get you on-line.

Email: contractor@scolmore.com

Scolmore® Group App

The Scolmore® Group app allows you to use your smart phone to browse our complete range of products, add products to your Favourites or to the Quote Basket and allows you to email the contents of the basket back to yourself.

With Scolmore®, Ovia® Lighting, ESP® & Unicrimp® products available you can use the search facility to easily locate the products required.

Our App also has a useful tool kit featuring:

Quick Quote Calculator, Zs Values, Cables Selection & Voltage Drop, Adiabatic Equation Calculator, Power Factor Calculator, KVA Converter, Lighting Cost Saving Calculator, Lighting No. Calculator and many more...



Marketing Hub

The Marketing Hub is the latest update to the Scolmore® website giving customers the opportunity to enhance their own marketing facilities with very little effort or cost. A selection of templates are available featuring many of our popular products. These templates can be customised with our stockists' details to provide maximum impact and optimise local sales opportunities.



Call: 01827 63454

Are you a Click® stockist?

If so, you automatically have access to the Marketing Hub. Download all our latest literature, flyers to personalise and our full range of images for use on your website or artwork. Follow the links from www.scolmore.com for more information.

marketing.scolmore.com



Lighting solutions optimised for performance,
energy efficiency and safety...



OVIA® Lighting

Already synonymous with superior performance and innovation following eight years of success as a leading name in the lighting industry, the OVIA® brand of lighting solutions has been further developed to meet the growing opportunities that the transformed lighting industry offers.

Our aim quite simply is to bring to market - on the back of extensive research with customers and contractors - a range of OVIA® lighting products that will provide contractors with the quickest and easiest to install lighting solutions that will save them time and money on a project and that they can source through the reliable wholesale channel.

Today, the comprehensive collection of lighting products from OVIA® will provide solutions for a whole spectrum of projects in a broad variety of sectors, including domestic, commercial, industrial, utility, amenity, emergency lighting and floodlighting. The lighting offer is further enhanced with the inclusion of a full range of lighting control solutions that will optimise energy saving credentials.

Flow



Domestic

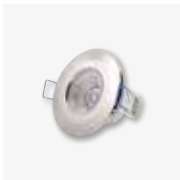

Commercial



Utility

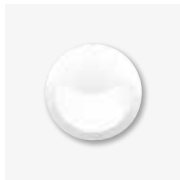

Industrial

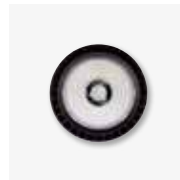

Emergency





CT300

250V 20A 4 pin (1 in 3 out)
Flow™ hub junction box

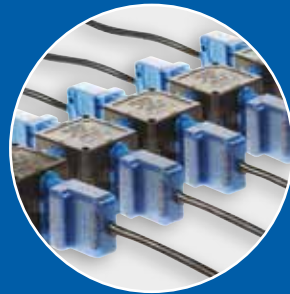

Hubs can be linked together in a chain



CT203C

- Quick release lockable covers
- 4 pole plug-in connector with auxiliary terminals
- Fast-fit cable clamps
- Auxiliary provides the opportunity for a second switched live or permanent feed for use typically with emergency lighting applications

The Hub

Designed to take the 3 pole or 4 pole plug-in connector versions, giving contractors the flexibility to arrange circuits easily and quickly.

- One hub can be connected directly to another or via the Flow™ link cables
- A quick and easy solution when adding lighting or appliances to an existing Flow™ circuit (can be linked up to 20A)

New low maintenance Push-Fit Connectors...

our new connectors require no screws and are low maintenance with push fit lever terminals, fast fit cable clamps and easy lock and release covers.

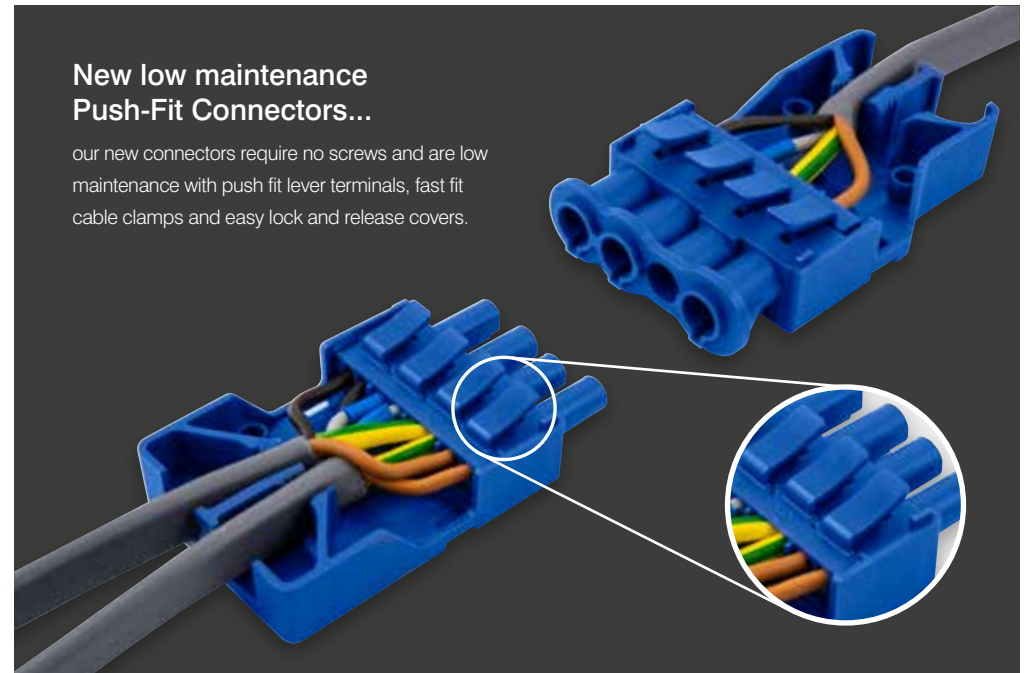

CT105M

- Push-fit terminals
- Fast-fit cable clamps
- Easy lock and release



CT115F

- Push-fit terminals
- Fast-fit cable clamps
- Easy lock and release
- With additional loop terminal

We've shown just a sample of the Flow™ option. To see the full range or for more details, log onto www.oviaUK.com to download the Flow™ section.



Connectors, Hubs & Management Boxes

The lighting management system is a new range of additional products to the existing Flow™ range and has been designed specifically to help contractors create more complex lighting installations quickly, easily and safely. It features a number of new products that allow the quick connection, configuration and re-configuration of circuits, primarily intended for lighting.

Key Features of the Lighting Management Boxes:

- Suitable for loads up to 20A which means it can be used for more than just lighting
- Management boxes can be controlled or dimmed using suitable PIR sensors or mains dimmers
- Can incorporate wireless switching and dimming scenarios using Click® Smart products
- Durable heavy duty finish to withstand all installation requirements
- Ample fixing points to suit any method of installation

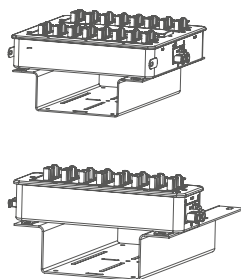

CT1016

Use the CT1016 to take control of up to 16 lights (24 using the CT350), with three different switching configurations. Easily add a switched live into a Flow™ circuit.

- 16 way configurable box
- 1 x 16 way (1 way switching)
- 1 x 16 way (2 way switching)
- 2 x 8 way (1 way switching)
- Additional 8 ways available using CT350 splitter
- Additional way allows interlinking

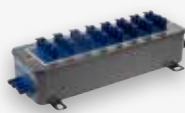

CT1008

With the CT1008 you can connect up to 8 lights (16 using the CT350), or you can connect another CT1008 to the output at the end.

- 8 way box
- Connect up to 8 lights (16 using the CT350)
- Additional output allows interlinking or provides additional way



CT2300

Plug-in switch adapter easily adds a switched live into a Flow™ circuit.

- Pre-wired with earth and neutral links
- 250V–20A plug-in connector
- Large terminals with easy access
- Terminal screws supplied raised
- Easy lock and release mechanism
- Versatile, easy-connection system

Quick and Simple...

using a combination of connectors, hubs & management boxes wiring a lighting circuit is easy.

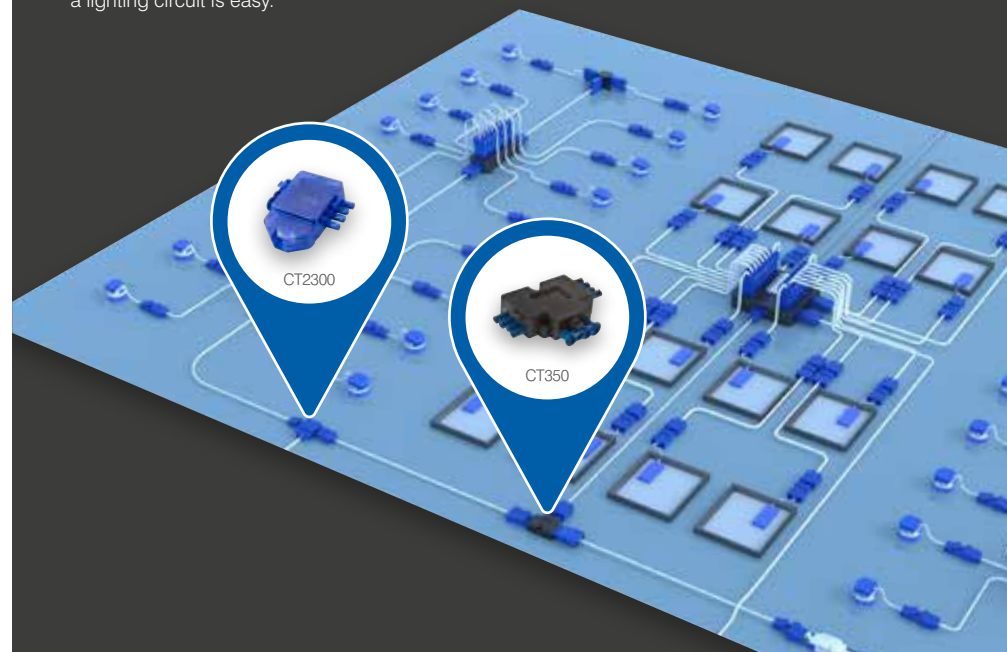

CT355

Flow™ (1 in, 2 out) 4 pole splitter. The splitter is compatible with 3 or 4 pole Flow™ connectors. Also requires 1 x female & 2 x male connectors.

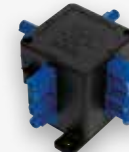

CT300

4 pin (1 in, 3 out) Flow™ hub junction box. The hub can also be connected directly to another hub.

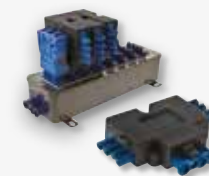

CT350

This splitter has been specifically designed to be slimline so that it can be used with the CT1016 and CT1008.

- Allows up to double the amount of ways
- Easy lock and release mechanism
- Versatile, easy-connection system



CT2300

- L (Switched Live)
- ⊕
- N
- PL

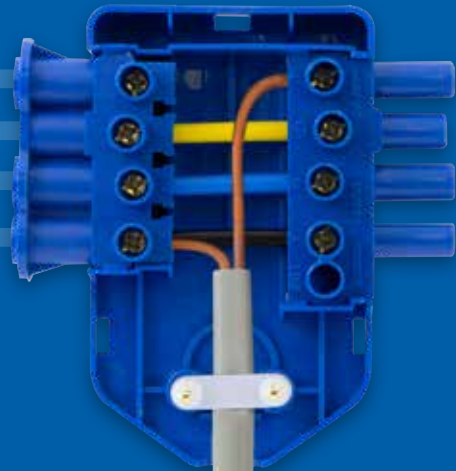

Switch Adaptor

We recognise that your time is money, our plug-in switch adaptor easily adds a switched live into a Flow™ circuit. With easy access large terminals and fast connection.

CT2300

- 250V~20A plug-in connector
- Large terminals with easy access
- Terminal screws supplied raised
- Easy lock and release mechanism
- Versatile, easy-connection system



CT102C

- 3 pole plug-in connector with loop terminal. Cable grips for where the installation limits the fixing of the connector
- Cord restraint is fitted within the male connector

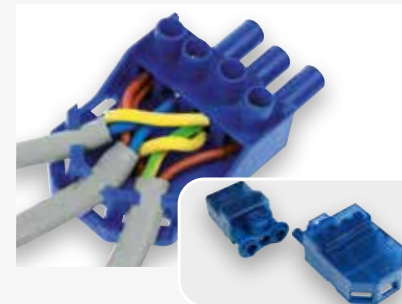

CT101C

- Increased load handling with 20A rating
- Male: Max 1.5mm² 3 core cable; Female: Max 3 x 2.5mm² twin and earth (with additional loop terminal)
- Also available on a range of FlameGuard® and Inceptor® downlights



CT202C

- 4 pole plug-in connector with auxiliary terminals
- Auxiliary provides the opportunity for a second switched live or permanent feed for use typically with emergency lighting applications

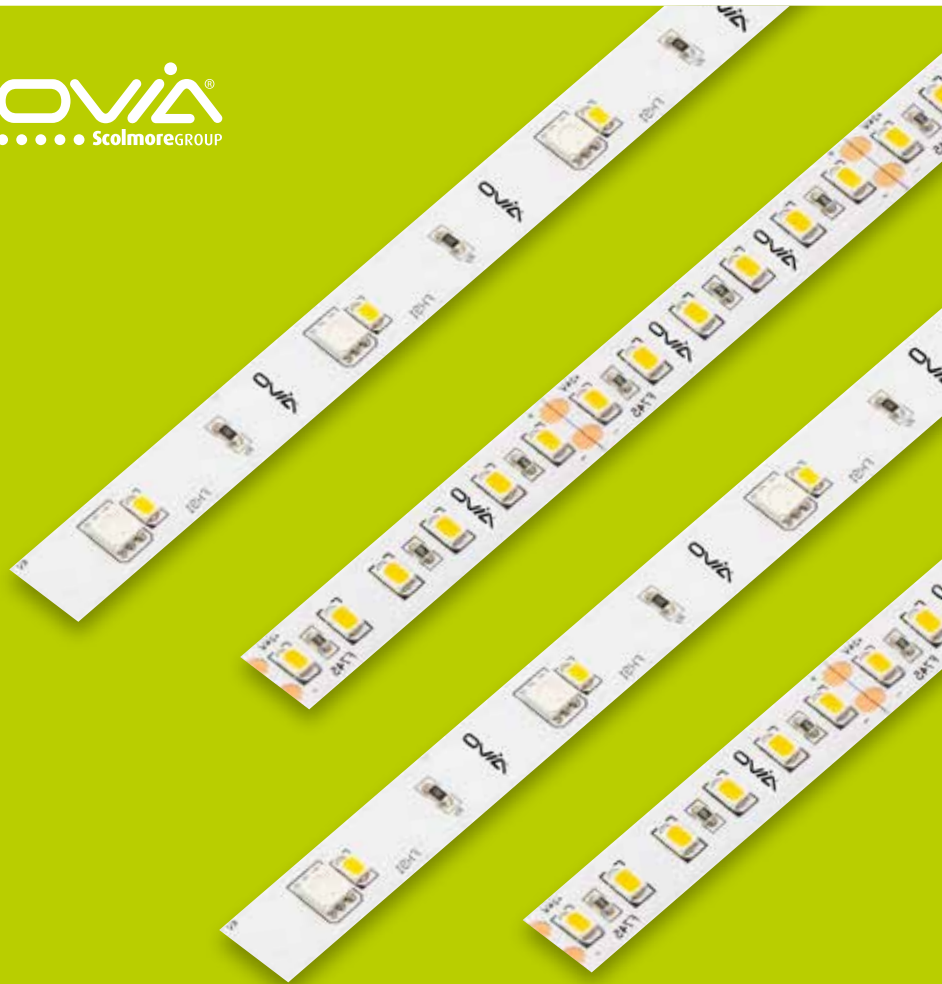

Inceptor® Intense

24V LED Strips

Inceptor® Intense is a full range of 24V LED Strips, available in cool white, warm white and RGBW. The plug and

play system is versatile with complete customisation with a variety of strips, connectors and drivers.

Features & Benefits...



3 Year
Warranty



Up to
IP65 Rated



Warm White &
Cool White Available



16 Million Colour
Options Available



Adhesive
Back

LED Strip Drivers

A variety of drivers to suit all types of LED Strip installations. Pick a suitable driver using the wattage and length of your LED Strip.



LED Strip Controllers

Our touch sensitive LED Controllers are required when operating the RGBW LED Strips. Choose between a panel or hand held remote controller.



Complete Customisation

Our LED Strips come in pre-cut lengths from 0.5m to 5m, offering complete versatility and ensuring a quick and easy installation.

This coupled with designated cutting points allows total flexibility for every installation.



FIRE RATED LED DOWNLIGHTS COMPLIANT IN ALL CEILING TYPES; SOLID TIMBER, I-JOIST & METAL-WEB



Inceptor® Omni V2

Fire rated fixed and adjustable downlights

The Omni V2 features an integrated 3 Pole Flow™ connector with built in driver and CTA switch which grants the ability to change the colour temperature instantly.

Omni V2 incorporates our award winning FlameGuard® system technology and

offers a 30, 60 & 90 minute fire rating and is acoustic and airflow compliant.

The new Inceptor Omni V2 also boasts a 53mm recess depth low profile installation with no insulation support bracket needed thanks to the Flow™ integrated driver.

Features & Benefits...



5 Year Warranty



Joist Fire Rated



Colour Temperature Adjustable



Dimmable as Standard

User Changeable Bezels



49MM Faceted Lens

The larger 49mm faceted lens provides outstanding performance, uniformity and glare control.

50mm Recess Depth

53mm recess depth low profile installation with no insulation support bracket needed thanks to the Flow™ integrated driver.

600 Lumen Light Output

The 6W Inceptor® Omni V2 has an upgraded internal driver which provides an impressive 600 (620 when in Cool White) lumen light output and a consistent 60° beam angle across all colour temperatures.

CTA Switchable

The Omni V2 features an integrated 3 Pole Flow™ connector with built in driver and CTA switch which grants the ability to change the colour temperature instantly.



Simple Connectivity & Control

FIRE RATED LED DOWNLIGHTS COMPLIANT IN ALL CEILING TYPES; SOLID TIMBER, I-JOIST & METAL-WEB



PRE-WIRED
flow
CONNECTOR

Inceptor® Nano⁵

4.8W Fire-Rated LED Downlight

The Inceptor Nano⁵ consumes less power and produces a comparable light output while reducing the size & cost. With a highly competitive price point for the features and benefits

offered, the new high-performance, 4.8W LED lighting products are designed to have mass market appeal and are suitable for a variety of uses in domestic applications.

Features & Benefits...



3 Year
Warranty



40°
Beam Angle



Cool White &
Warm White



30, 60 and 90
Minute Fire-Rating



Dimmable
as Standard

Integrated Flow™ Connector

An integrated 3 Pole Flow™ connector allows for quick and simple connection & disconnection for initial and periodic testing to be carried out.



Insulation Support Bracket

Sold Separately - the removable Insulation Support Bracket has been developed to allow installers to lay thermal insulation directly over the top of the Inceptor® Nano⁵. Creating a 20mm air-space above the driver allows air to circulate and cool, therefore the driver dissipates heat more effectively and in-turn lets the luminaire run cooler.



Fixed...



Adjustable...





FIRE RATED LED DOWNLIGHTS COMPLIANT IN ALL CEILING TYPES; SOLID TIMBER, I-JOIST & METAL-WEB



GU10 Sold Separately



Flameguard® Downlights

Fire rated downlights now with push fit Flow™

Ovia's fire-rated downlights have always been subject to the strictest test measures to ensure they offer full compliance and have the corresponding test certification to meet the very latest regulations.

As such, the Flameguard GU10 downlights, have all been tested for fire

resistance compliance with all ceiling types - solid timber, I-joists and metal web joists.

Ovia Lighting can confirm that it has successfully completed further fire resistance testing to demonstrate that its fire-rated downlights satisfy the new guidelines issued by the NHBC.

Features & Benefits...



5 Year Warranty



Joist Fire Rated



Up To IP65 Rated



Pre-wired Flow connector

Fire Defiant & Regs Compliant

30, 60 & 90 minute fire rating.



Solid Timber

Traditional solid wood joist which has been used in house building for decades.



I-Joist

Combining an engineered composite panel with high grade softwood.

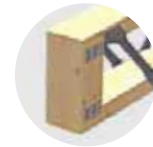

Metal-Web / Open Web / Posi Joist

Combination of timber runners with metal webbing.

PUSH-FIT Flow™ Connectors

Flow™ range has been designed specifically to help contractors create more complex lighting installations quickly, easily & safely. It features a number of new products that allow the quick connection, configuration & re-configuration of circuits, primarily intended for lighting.

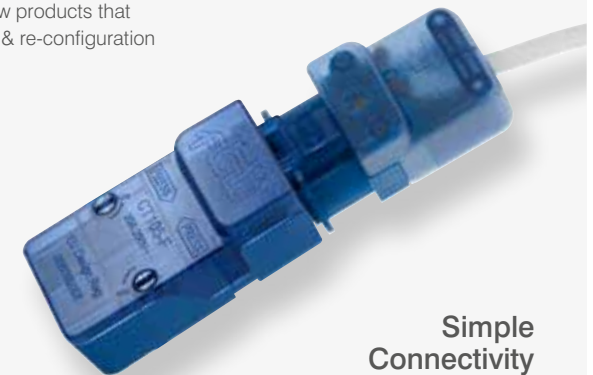

Simple Connectivity & Control



Garden Lighting

New Amenity lighting, wall & ground lights

Safety and security were the main consideration for the creation of the Amenity range of lighting products with an emphasis on the aesthetics of the product portfolio.

The range covers many applications, ranging from LED star lights through to external bollards and wall lights.

Features & Benefits...



Up To 50,000
Hour Lifetime



3 Year
Warranty



Warm
White



Cool
White



Wall Lights

A selection of our new wall lights are available in standard and PIR versions for automatic activation.



Ground Lights

A large selection of bollards to suit any application and the addition of a new spike light, ideal for adding ambience to your outdoor space.





Inceptor[®] Skylar UG16

Ultra Low Glare Panel Lights

The Inceptor[®] Skylar UGR16 has an ultra low UGR diffuser which minimises glare and focuses the light

towards the object of illumination with it's narrow 70° beam angle.

Features & Benefits...



5 Year
Warranty



Weatherproof
Rating



Dimmable
Available



Unified Glare
Rating



50,000 Hrs
Lifetime

Pre-wired Flow[™] Connector

The Tridonic driver's Fly-Lead comes pre-fitted with a male Flow[™] connector & a Fast Fit Female Flow[™] connector with push-fit terminals.



UGR Rating of <16

Minimises glare and refocuses the light towards the object of illumination with its narrow 70° beam angle.



Emergency & Dimming

Compatible with OVEMCG50 Emergency Pack & OVCGMF001 Multi-Function LED Driver to enable emergency operation and 3 different types of dimming operation.





Inceptor[®] Trofa

CTA Switchable LED Panels

The Inceptor[®] Trofa has a TP(a) thermoplastic rating, a CTA switch with 3

different colour temperatures and there is also a dimmable option available.

Features & Benefits...



5 Year
Warranty



Weatherproof
Rating



Thermoplastic
Rating



Colour Temperature
Adjustment



Dimmable
Available

Pre-wired Flow[™] Connector

The LED driver's Fly-Lead comes pre-fitted with a Male Flow[™] connector & a Fast Fit Female Flow[™] connector with push-fit terminals for quick and easy installation.



Emergency & Dimming

Enables the emergency setting as well as 3 different types of dimming. This is available in 3 colour temperatures.



CTA SWITCH

To easily switch between 3 Colour Temperatures 3000K (Warm White), 4000K (Cool White) & 6000K (Daylight).



PRE-WIRED
flow[™]
CONNECTOR

Inceptor[®] Slate Backlit UGR

30W 600mm x 600mm Low-Glare Backlit LED Panels

The Inceptor[®] Slate backlit UGR is TP(a) Rated Backlit range of UGR < 19 Panel Lights. The Inceptor[®] Slate Backlit UGR has a low UGR diffuser

with a TP(a) thermoplastic rating, making it suitable for all working environments.

Features & Benefits...



5 Year
Warranty



IP20
Weatherproof
Rating



TP(A)
Thermoplastic
Rating



50,000 Hrs
Lifetime



Dimmable
Available

Pre-wired Flow[™] Connector

The Inceptor[®] Slate Backlit UGR includes a pre-wired push-fit 3 Pole Flow[™] connector for quick & easy installation.



Installation Options

Suitable for a range of installation types. We have a Suspension Kit & Recessed Frames all available for use with the Inceptor[®] Slate Backlit UGR ceiling panels.



TP(a) Materials

The Building Regulations Approved Document B2 (buildings other than dwelling houses) places restrictions on the use of certain thermoplastic materials when they are used as lighting diffusers and form part of a ceiling. TP(a) rated materials may be used almost without restriction, but restrictions exist on the use of TP(b) rated materials. Inceptor[®] Slate ceiling panels are TP(a) as standard.



Inceptor[®] Apto

Adaptable Downlight with CTA Switch

The Inceptor[®] Apto is a range of commercial downlights with adaptable mounting options. The range features 3 sizes of downlights and one integrated PIR version.

Inceptor[®] Apto includes specially adapted spring features which enable the product to be retro-fitted into a range of cut-out sizes.

Features & Benefits...



3 Year
Warranty



Vented Thermal
Management



Fly Lead
Installation



Corridor Function
Version Available



Steel Safety
Loop

Corridor Function

The Inceptor[®] Apto has a PIR version which features a delay timer with five configurable options.

Adjustable Colour Temperature

A built-in three position switch which grants the ability to change the colour temperature instantly. CTA colour temperature switch with a range of 3000K, 4000K, 6000K, making it suitable for a wide range of locations.

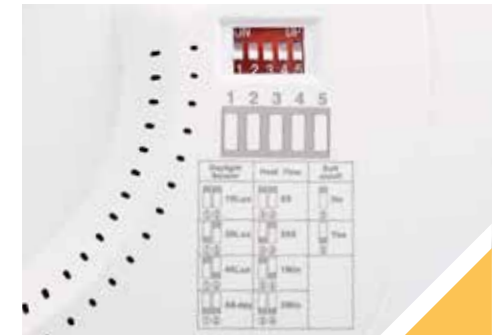

Magnetic Bezels

Available in Satin Chrome, Chrome and Black.
(Excluding PIR versions)

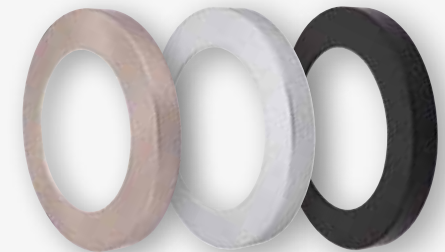



E-Sprite

Eco Commercial LED Downlights

The E-Sprite is available in 9W, 15W, 25W or 30W. Supplied with CTA Switches as standard & pre-wired with

a Fast Fit Flow[™] connector or 3 in multi-function dimming option for quicker and easier installation.

Features & Benefits...



3 Year
Warranty



IP20
Rated



30,000 Hour
Lifetime



Colour Temperature
Adjustment



100°
Beam Angle

Multi-Function Dimmable



Our E-Sprite fittings can be used with our Multi-Function Constant Current LED Drivers on all 3 CTA Switchable Colour Temperatures. For extra versatility the range is also Compatible with the 4W Universal Emergency Pack.



Call: 01827 300640

CTA Switch



Easily switch between 3 Colour Temperatures 3000K (Warm White), 4000K (Cool White) & 6000K (Daylight).

Fast Fit Flow[™] Connector

The E-Sprite includes an pre-wired push-fit 3 Pole Flow[™] connector for quick and easy installation.



75



Inceptor[®] Duo

Up & Down Linear Luminaire

The Inceptor Duo is a sleek up & down dimmable linear luminaire. The fitting is available in 2 lengths

and 3 different colour options to suit all décor. Available in Standard & Emergency.

Features & Benefits...



5 Year
Warranty



Weatherproof
Rating



Emergency
Version Available



Dimmable
Available



50,000 Hrs
Lifetime

Dual CTA Switch

2 CTA switches provided to allow the end user to individually change the top LED and bottom LED light source. All models can change between, 3000K, 4000K, 6000K and OFF.



2 Wattages, 2 Sizes

Slim design, available in 2 lengths.

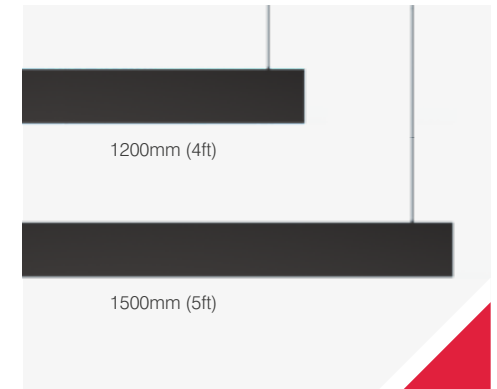

3 Finish Options

Available in Black, Grey and White.



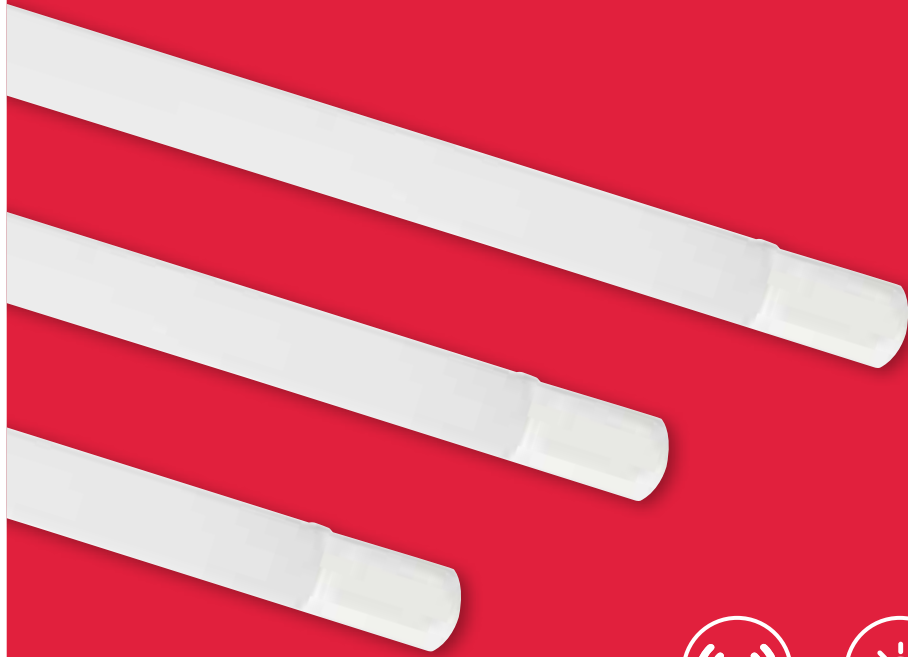

Microwave Available



Emergency Available

Inceptor[®] B-Lite

4FT, 5FT & 6FT Linear Batten Multi-Current LED Light

The Inceptor[®] B-Lite available in 3 different lengths, has TP(a) thermoplastic rating and has a strong IK08 impact protection which means it is suitable for many applications. The Multi Current Driver provides the option

to increase or decrease the lumens to suit each individual application Easily pull apart the diffuser from the steel base with the help of spring clips, making it quicker and easier for installation.

Features & Benefits...



5 Year Warranty



Weatherproof Rating



Impact Protection



Thermoplastic Rating



50,000 Hrs Lifetime

Base to Diffuser Clips

Spring steel base to diffuser clips makes it quick and easy to remove the diffuser from the base by simply pulling the two parts away. This speeds up installation time.



Multi Current Driver

Multi Current Driver with the option of 4 different wattages. This allows you to increase or decrease the lumens depending on where you would like to install the Inceptor[®] B-Lite.



Safer Installation

Security wire allows safe and easy installation. The security wire allows for the diffuser to be hung from the base of the product whilst installing, preventing the installer removing the cover and placing aside whilst installing.





1800mm (6FT)



1500mm (5FT)



1200mm (4FT)



Microwave Available



Emergency Available

Inceptor[®] U-Lite

4FT, 5FT & 6FT Linear LED Lights

Our non-corrosive design, protected against the elements, Inceptor[®] U-Lite fittings are available in 3 different

lengths and each length is available in a single fluorescent lamp equivalent and a twin lamp equivalent output.

Features & Benefits...



5 Year Warranty



Weatherproof Rating



Impact Protection



Colour Temperature



50,000 Hrs Lifetime

Easy Install

Our U-Lite LED lights are suitable for wall, ceiling or suspension mounting and its adjustable fixing centres allow for easy retrofit instalment. The addition of Push Fit Terminals offers fast, simple and clear installation.



Multi Current Driver

By integrating the diffuser & gear tray and anchoring them to the base, the U-Lite ensures a hassle-free installation. Complete your installation without having to fully disassemble the product to mount and wire it. Never lose parts! With everything you need pre-fitted to the base you'll never have to worry about misplaced control gear.



Anti Tamper Clips

Anti tamper clips allow the installer to screw the retaining clips so that others cannot open the light fitting without the use of a tool.

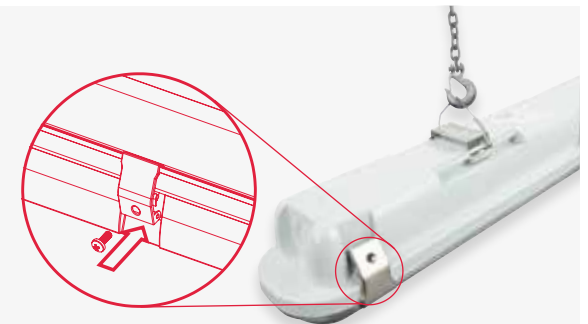

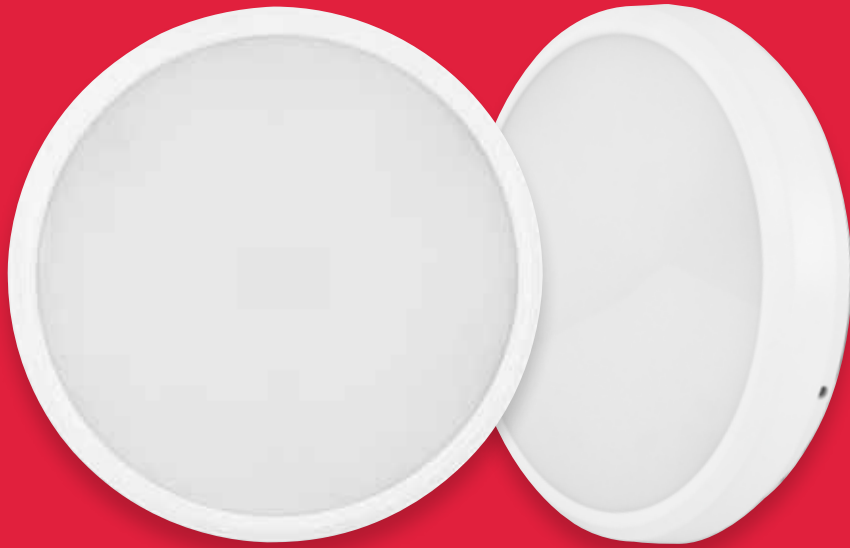

Evo Slim & Slim Mini

IP65 CTA LED Bulkhead

Ideal for a variety of lighting applications the high performance, reliable IP65 LED bulkhead gives you the option of Cool White, Warm White and Daylight colour temperatures.

Available with corridor function, Microwave sensor or Emergency; the Evo Slim & Slim Mini is suitable for any situation.

Features & Benefits...



5 Year
Warranty



IP65
Rated



Microwave
Sensor Version



Corridor
Function Version



Emergency
Version

Colour Temperature Adjustable

All models include a CTA switch allowing the product to change colour temperature between Warm White 3000K, Cool White 4000K and Daylight 6000K.



Fast-Fit Twist & Lock Installation

The twist and lock process saves time during the installation which simplifies the maintenance and servicing of the luminaire.



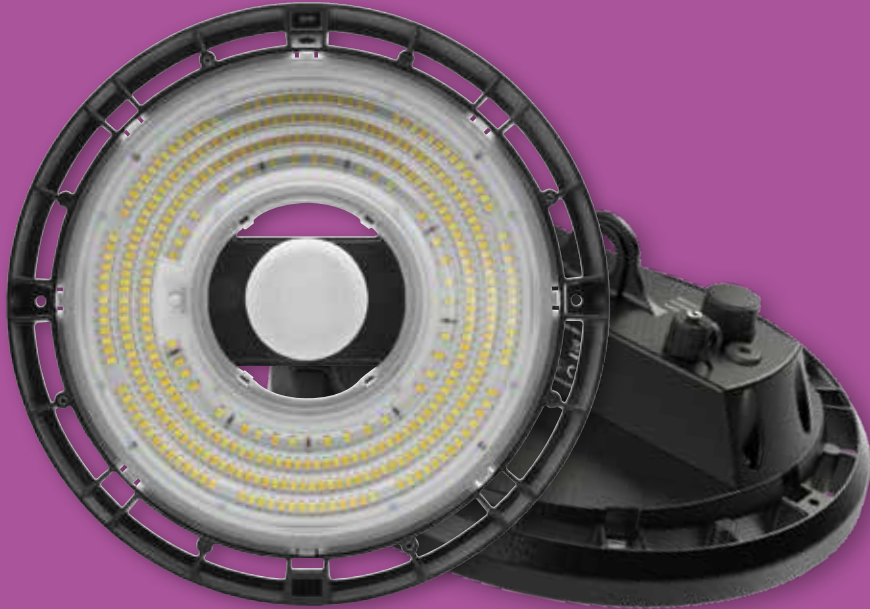

Mounting Bracket
(sold separately)

Inceptor[®] Hi-Lite

LED Dimmable Highbay

We have two versions of this fitting, a 0(1)-10V dimmable and a Microwave Sensor version. Both boast an IP65 and IK10 rating, IK10 is one of

the highest degree of mechanical protection defined by BS EN 62262: 2002 standard.

Features & Benefits...



6 Year
Warranty



IP65
Rated



50,000 Hour
Lifetime



90°
Beam Angle



Dimmable
Available

Energy Saving Sensor Activation

The Inceptor[®] Hi-Lite allows you to save energy with the built in sensor by activating lights only in areas that are occupied.

*MICROWAVE SENSOR VERSION AVAILABLE.



Colour Temperature Adjustable

The Inceptor[®] Hi-Lite has the ability to change the colour temperature between 4000K Warm White, 5000K Cool White and 6500K Daylight.

CTA switch is located inside the IP65 threaded cap.



Fitting Accessories

Bracket mount for Inceptor[®] Hi-Lite Highbay Fittings.



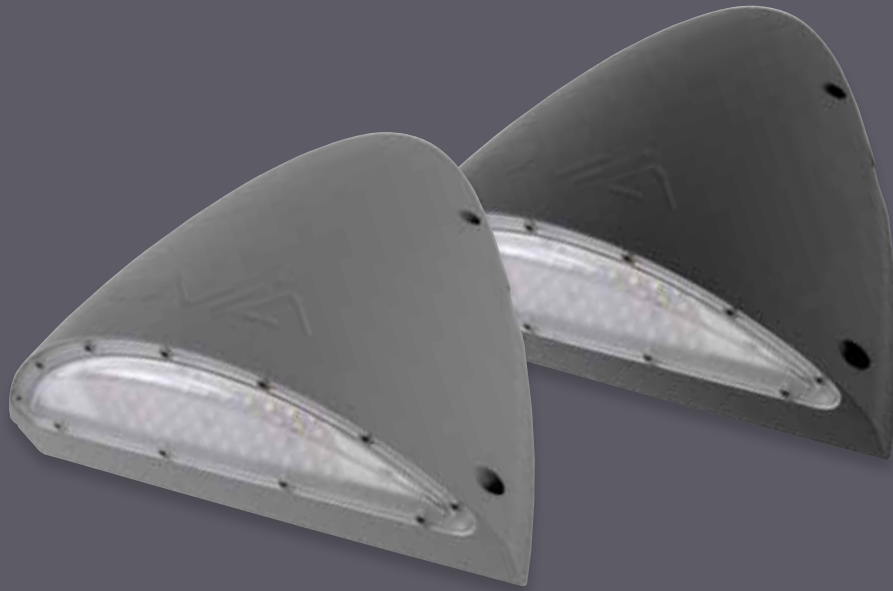

Emergency Available

Inceptor[®] Murus

LED Wall Pack

A range of LED wall packs, boasting an IK10 rating, ideal for use in outdoor environments.

Available in either Anthracite Grey or Light Grey finishes.

Features & Benefits...



5 Year Warranty



IP66 Rated



Impact Protection



ME1-2 (TYPE II) 80°x140° Beam Angle



Piano Key Terminal

Photocell Version

A photocell can help the customer save energy by allowing the light to turn on and off at set lux levels.

The Inceptor[®] Murus will turn on when the lux level is below 10-30 lux.

Colour Temperature Adjustable

All models include a CTA switch allowing the product to change colour temperature between Warm White 3000K, Cool White 4000K and Daylight 6000K.



BESA Box & Trunking Mountable

The backplate can be mounted on a BESA/Conduit box & Trunking. Two areas allow a BESA/Conduit box to be mounted, one of which sits recessed into the base of the light. The user can use trunking to feed wires through and allow the light to sit surface mounted against a wall.

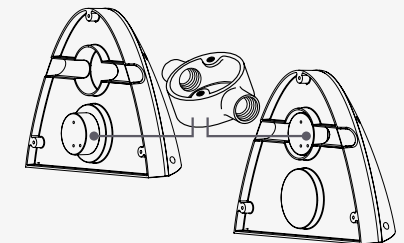



Inceptor[®] Ace

LED Asymmetric Floodlight

Inceptor[®] Ace adjustable asymmetric floodlights provide a high quality range of indoor and outdoor lighting

with modern aesthetics. Up to 300W versions available in a Black finish with 4000K Cool White LEDs.



Colour Temperature



Photocell Sensor Available

Features & Benefits...



5 Year Warranty



IP65 Rated



IK06 Impact Protection



60°x120° Beam Angle



50,000 Hrs Lifetime

2M Pre-Wired Flex

2 metre pre-wired flex cable for quick and easy installation.



Angle Adjustable Bracket

Fully adjustable bracket allowing full control of the projection angle.



Asymmetric LED Lens

Specifically designed lens inserts to direct each LED.





Gator

LED Street Lighting

Ideal for lighting larger outdoor areas. Our Gator LED Street Lights are designed to be easy to install via toolless entry.

Toolless Opening



Toolless gear tray removal for ease of maintenance.

Features & Benefits...



5 Year Warranty



IP66 Rated



Impact Protection



ME1-2 (TYPE II) 85°x150° Beam Angle



50,000 Hrs Lifetime

Reversible Mount

Rotate and pivot the mount bracket to allow for vertical or horizontal fitment with no additional joints required. The Spigot size is 76mm and a Wall Bracket for these products is available.

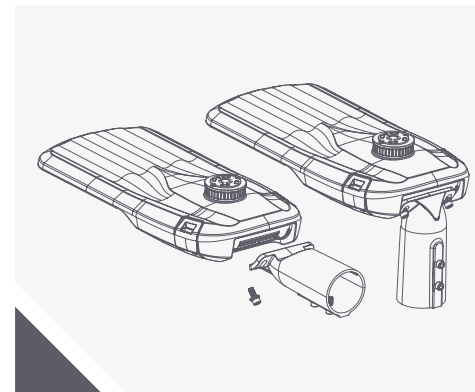

CTA Switch

All models include a CTA switch allowing the product to change colour temperature between Warm White (3000K), Cool White (4000K) and Daylight (6000K).

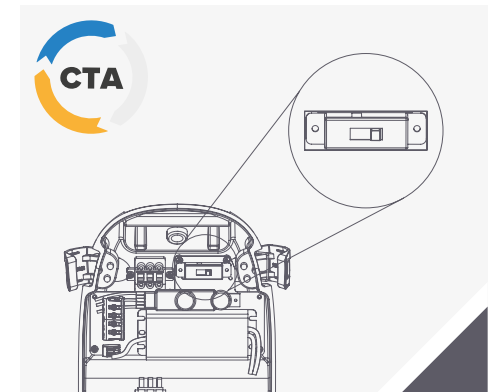

Photocell Accessory

The shorting cap can be replaced by a photocell sensor.





Inceptor[®] Hulke

Emergency LED Maintained Hinged Bulkhead

The Inceptor[®] Hulke features a hinged lid design to assist with installation and is made from a light weight polycarbonate housing making it suitable for ceiling or wall mounting. The Inceptor[®] Hulke includes large

20mm cable access points to further assist the install process. It also offers three hours emergency duration, with charge and discharge protection, and features a green LED charge indicator.

Features & Benefits...



4 Year
Warranty



IP65
Rated



3 Hour
Emergency Duration



30,000
Hour Lifetime



110°
Beam Angle

Emergency Bulkhead Legends

Inceptor[®] Hulke comes with interchangeable emergency bulkhead legends giving you everything you need to complete your installation.



Replacement Battery

Inceptor[®] Hulke comes with a replacement battery as standard and features a 3.6V 900mAH NI-CAD Battery that has a 3 hour emergency duration with a emergency light output of 107 Lumens.



Hinged Lid

Featuring a hinged lid to facilitate quicker and easier installation which will allow an overall reduction in the time taken to fit the product.



OVIA® Website

The OVIA® website showcases the full range of quality, cost effective products currently on offer. With regular updates on new products, as well as details of developments within our business, the site is a great source of information keeping you fully up to date with the click of a button.

- Product Finder
- Technical Specification Brochures
- Product Technical Specification Sheets
- Photometrics
- Instruction Manuals

Online Ordering

The site now incorporates a number of improved features that allow users to access new information directly and easily:

- Ordering 24 hours a day 7 days a week with the ability to check current stock levels as required, meaning you are not restricted to ordering during normal office hours.
- Access to on-line catalogues will keep you fully updated with the complete product range and provide information on new products as and when they become available.
- The order tracking service keeps you up to date with the progress of your shipment.
- Managing your administration paperwork is now even easier with instant access to reports and essential documents at a click of a button.
- A 'quick buy tab' and the ability to store the most common orders for repeated use, adds to the versatility and flexibility of the revised system.
- PDF purchase order uploads now available. You can now take your purchase order directly in PDF format and upload it to automatically extract the data and validate its contents.

www.oviaUK.com

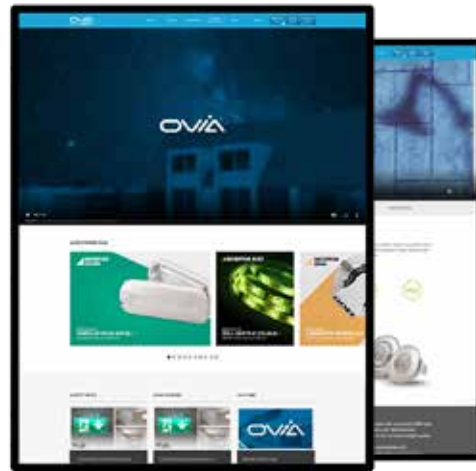

OVIA® Product Finder

The OVIA® product finder tool makes it easier than ever for electricians, wholesalers and end users to search and locate products from across all categories, with just a few clicks.



To Register: E-mail us at sales@oviaUK.com or call our Sales Office on **01827 300 640** and one of our Sales Representatives will be more than happy to get you on-line.

Email: contractor@scolmore.com

Scolmore® Group App

The Scolmore® Group app allows you to use your smart phone to browse our complete range of products, add products to your Favourites or to the Quote Basket and allows you to email the contents of the basket back to yourself.

With Scolmore®, Ovia® Lighting, ESP® & Unicrimp® products available you can use the search facility to easily locate the products required.

Our App also has a useful tool kit featuring:

Quick Quote Calculator, Zs Values, Cables Selection & Voltage Drop, Adiabatic Equation Calculator, Power Factor Calculator, KVA Converter, Lighting Cost Saving Calculator, Lighting No. Calculator and many more...



Marketing Hub

The Marketing Hub is the latest update to the OVIA® website giving customers the opportunity to enhance their own marketing facilities with very little effort or cost. A selection of templates are available featuring many of our popular products. These templates can be customised with our stockists' details to provide maximum impact and optimise local sales opportunities.



Are you an OVIA® Elite Stockist?

If so, you automatically have access to the Marketing Hub. Download all our latest literature, flyers to personalise and our full range of images for use on your website or artwork. Follow the links from www.oviaUK.com for more information.

oviauk.com/marketinghub



Call: 01827 300640



Fire and Security Products...



Elite Security Products

ESP® (Elite Security Products) Ltd is a market-leading supplier of a comprehensive range of electronic security and fire protection products.

The emphasis of activity has been on the development of security related products specifically for the UK electrical trade. By keeping a close eye on the new technology that is emerging from the professional security sector and gauging the right time to introduce it to the electrical contract market, ESP® helps customers stay one step ahead.

ESP® has been part of the Scolmore® Group of companies since 2011, and whilst the company operates independently, ESP® benefits from the expertise, knowledge and support of the Scolmore® Group and continues to create strong growth within its product categories.

ESP's comprehensive portfolio includes; Smart Security, CCTV, Access Control, Evac, Fire Protection, Emergency Lighting, Essentials, Sangamo Time Switches and Heating Controls.

Fort Smart Security

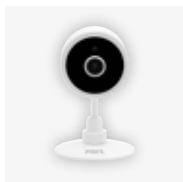

CCTV



Fire Protection



Access Control



Emergency



Evac



Fort®

ESP®
ScolmoreGROUP



Smart Security

Smart solutions for a safer & more comfortable home

Discover a whole range of smart home products. From smart alarm kits, smart cameras, smart sensors and smart door bells, all working together to make your home smarter and safer.

The installation of the Fort range is simple & flexible, making it ideal for

installation within existing or newly constructed buildings.

Each smart product comes with easy to follow installation guides which are also accessible through the new Click Smart+ app.

www.espuk.com

Email: contractor@scolmore.com

Multiple Smart Alarm Kits Available



 ClickSmart+

All of ESP's Fort products are compatible with the Click Smart+ app.

Call: 01527 515150



99



Fire Panels

2, 4 and 8 Zone Two Wire Fire Panels

Two-Wire fire alarm systems are based on standard conventional system technology. Unlike standard conventional four wired systems where the detectors, call points and alarm devices for each zone are wired on separate circuits, MAGDUO utilises intelligent Two-Wire technology, which allows all devices to be wired on the same set of two-core zone cables back to the control panel - enabling it to

use a single circuit per zone both for detection and to power the sounders. This advanced technology can reduce both installation and material costs. With its adaptability, speed of installation and cost-effectiveness, MAGDUO provides an ideal fire alarm solution for a range of small to medium sized projects such as restaurants, retail outlets, schools, offices, apartments and hotels.

Installation Example



Key Features

- Two wire fire alarm system
- Active end of line monitoring and head removal
- Up to 32 devices per zone (dependent on device loading Unit: DLU)
- 4 line x 20 character LCD display
- Ability to differentiate between smoke detector, heat detector or a manual call point alarms
- Alarm confirmation feature
- Event log storing up to 500 events
- 3 enhanced test modes
- Configured to day/night detection mode
- Delay programming options
- Certified to EN54 2/4 Standards
- Requires 2 x 12V 2.3Ah batteries (BAT32)
- Optional extended battery box with capacity for 2 x 12V 7.0Ah batteries



Fire System Devices

Conventional & Addressable Fire Alarm Systems

MAGfire offers a comprehensive product line up that is fully compliant with the very latest Construction Products Regulation. The MAGfire range covers conventional, or four-wire, fire alarm systems which

have been traditionally used in smaller properties such as shops and restaurants, as well as addressable systems which are suitable for large commercial premises and more complex networked systems.

Conventional System Cabling

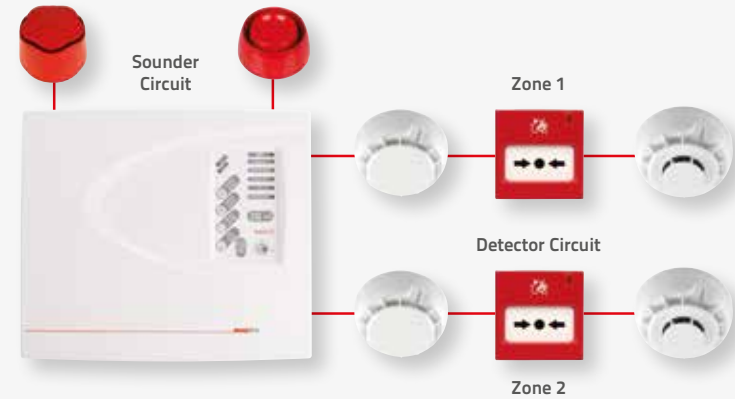

- Detectors and Call Points are wired onto circuits known as the Zone Circuits
- Sounders and Strobes are wired on a separate circuit known as the Sounder Circuits
- In an event of a fire, the fire alarm panel will indicate which Zone has been activated.

Addressable System Cabling



- Detectors, Call Points and Sounders are wired onto the same circuit known as the Loop Circuit (Ring Main)
- In an event of a fire, the fire alarm panel will indicate exactly which Device has been activated.



Door Entry Kit

Aperta Single Door Internal Keypad Kit

- Easy install, simple self-contained programming access control system
- Complete with proximity keypad, green mushroom push to exit button, electro-magnetic lock, emergency call point, and system power supply
- Supports up to 1,010 key tags or pin numbers
- Anti-tamper option
- Robust construction with IP65 ingress protection
- 10 tags included

Electromagnetic Lock

Holding force 250kg/550lbs max. Z & L mounting bracket included. Fail safe and dual voltage 12 and 24 VDC.



Power Supply

100-240VAC, 50/60Hz input. 1.5A/12VDC fail safe/secure output. 1A 12VDC standard output.



Emergency Break Glass

Emergency break glass to release door. Can easily be surfaced mounted.



Proximity and Keypad Door Entry

Boasting an IP rating of 65, the EZTAG3 comes complete with 10 proximity tags. The EZTAG3 is easy to install with a simple self-contained program. You can also have 2 separate user groups. Anti-tamper option available.



Contactless Exit Button

DC12V Input. 12-28V, 3A Rated Contact.



Push to Exit

With a stainless steel fascia, the large mushroom exit button has clear wording to the face. Normal open and closed contacts.





Emergency Exit Sign

3W LED Maintained Emergency Sign Complete with All Legends

The Duceri emergency lighting range from ESP offers installers and designers a comprehensive range of independently tested products which combine high performance with ease of installation.

The 4-in-1 Maintained Slimline Exit Box is manufactured from polycarbonate to offer a compact and lightweight alternative to the traditional steel exit boxes and it is supplied with all directional PVC legends (Up, Down, Left and Right).

Key Features

- 6500K Colour Temperature
- 3W 20 SMD 3014 LED + 5 SMD 2835 LED
- Polycarbonate Frame, PVC legends
- Wall Mounted
- 45 Lumen Mains Output
- 34 Lumen Emergency Output
- 29m Viewing Distance
- Charge and Discharge Protection
- 3 Hours Emergency Duration
- 3.6V 800mAh Ni-Cd Battery
- IP20 Ingress Protection
- BS EN 60598-2-22
- Legend Dimensions - 320 x 185 x 26mm
- Weight - 0.6Kg



4 in 1 Slimline Exit Box

This Emergency Exit Sign comes supplied with interchangeable legends giving you everything you need to complete your installation.





Assistance Alarms

Disabled Toilet Alarm with Battery Backup

Beacon's Assistance Alarm Kit is a simple to install 3-part kit designed to meet the criteria of care standards set out in Part M building regulations and British Standard BS8300. It comprises of an Indication Module, Pull Cord Module and Reset Module. The alarm kit now comes in urea formaldehyde which has antimicrobial properties - making it an ideal choice for hygiene sensitive

applications. When independently tested, the modules proved to be 99.99% effective in reducing Escherichia coli and Staphylococcus aureus.

The assistance alarm kits are also available in a stainless steel finish to maximise their appeal across a broad range of applications.

Available in Different Finishes

The assistance alarm kits are also available in a stainless steel finish to maximise their appeal across a broad range of applications.



Key Features

- Simple install, 3 part kit - Indication Module, Pull cord module & Reset Module
- Battery backup function for mains power failure
- Toilet alarm designed to raise alert for assistance
- Meets Part M building regulations and BS8300
- Alarm to raise alert for assistance
- Compact design to suit many interiors
- Disabled persons door sign
- System is expandable to include additional indication and pull cord modules



Antimicrobial Assistance Alarm

Manufactured from urea formaldehyde which has antimicrobial properties - making it an ideal choice for hygiene sensitive applications. When independently tested, the modules proved to be 99.99% effective in reducing Escherichia coli and Staphylococcus aureus.



SANGAMO

Time switches and heating controls...



Sangamo

Founded in 1921 and proudly manufactured in the UK, Sangamo is recognised as one of the world's leading design and manufacturers of a wide range of electrical measuring and control equipment.

The experienced UK production team at Sangamo, located in Port Glasgow, have been manufacturing time switches in the UK for over 65 years.

Sangamo joined the Scolmore® Group of companies in 2018. The additional expertise, knowledge and support of the Scolmore® Group has strengthened and continued their ability to offer a wide range of time switches and heating controls for domestic, commercial and industrial use.

With an unrivalled reputation for quality and reliability, they have built strong relationships with the UK and Ireland's major electrical wholesalers.

At Sangamo the customer service and technical support teams are knowledgeable and experienced, meaning they can confidently offer tailored solutions to companies and organisations, providing customised products to meet the needs of every single customer.

Choice



Choice+



Powersaver



Powersaver+



Round
Pattern Time
Switches

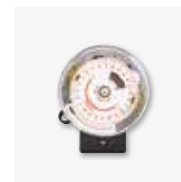

DIN &
Panel Time
Switches



SANGAMO

Round Pattern Time Switches

The Sangamo Round Pattern Time Switch (or RPTS) is well known for its quality and reliability. All models can switch up to 20A and are fully manufactured in the UK.

The longevity of these timers is legendary, a recent survey found many lasting three, four and even five decades. Many outlasted their original purpose and were reinstalled a second or third time.



5 Year
Warranty



3600W LED
Available



400W LED
Available

Choice Plus Programmers & Thermostats

A Choice+ Programmer allows the occupant to specify when a call for heat is made in order to match their lifestyle and ensuring energy efficiency.

Choice+ thermostats include TPI feature to ensure a maintained temperature by analysis of the heating and cooling periods. Choice+ programmable thermostats include Optimum Start and Delayed Stop for additional efficiency, heating and cooling for the time programmed.



3 Year
Warranty



Backlit Displays
Available



www.espuk.com

Email: contractor@scolmore.com

DIN & Panel Time Switches

All Sangamo's DIN Rail mountable time switches are designed for 35mm "Top Hat" rail. Switches come in 1, 2 or 4 modules, each module is 17.5mm wide, which fits the required width in the DIN enclosure.

The panel time switch range can also be surface or din rail mounted. The analogue 16000 range are simple to use and are a cost effective timer. They are extremely easy to set, change and to view programmes.



3 Year
Warranty



Backlit Displays
Available



Bluetooth
Available



Powersaver Plus Controllers

The primary application for the Powersaver range is to control immersion heaters. Immersion heaters are often rated at 3KW which, if left on permanently, can cost around 13p per hour/ £1.56 per day/£9 per week/ £450 per year, so it is best to have control of your heating patterns.

Fitting a Sangamo immersion heater controller can reduce these costs by up to 50%, even more if the property can take advantage of a dual tariff electricity and controlled by the Powersaver Dual Flexi.



3 Year
Warranty



Backlit Displays
Available



Call: 01527 515150

113

ESP® Website

The refreshed site provides customers with access to detailed product information for the company's extensive range of security products, which includes CCTV, access control, fire protection, emergency lighting, essentials, time switches and heating controls.

With regular updates on new products and details of developments within the business, the site is a great source of information. The full product range can be found online with specific information about each product and access to the latest catalogues.

Online Ordering

The site now incorporates a number of improved features that allow users to access new information directly and easily:

- Ordering 24 hours a day 7 days a week with the ability to check current stock levels as required, meaning you are not restricted to ordering during normal office hours.
- Access to on-line catalogues will keep you fully updated with the complete product range and provide information on new products as and when they become available.
- The order tracking service keeps you up to date with the progress of your shipment.
- Managing your administration paperwork is now even easier with instant access to reports and essential documents at a click of a button.
- A 'quick buy tab' and the ability to store the most common orders for repeated use, adds to the versatility and flexibility of the revised system.
- PDF purchase order uploads now available. You can now take your purchase order directly in PDF format and upload it to automatically extract the data and validate its contents.

www.espuk.com

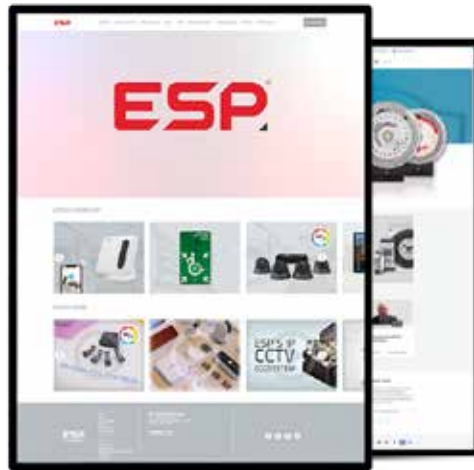

Stockists can also take advantage of a comprehensive product image library, plus a range of literature covering every product category - all available to download at the click of a button. Visitors can keep informed of the latest new products and company developments via regular updates on the news section.



To Register: E-mail us at info@espuk.com or call our Sales Office on **01527 51 51 50** and one of our Sales Representatives will be more than happy to get you on-line.

Email: contractor@scolmore.com

Scolmore® Group App

The Scolmore® Group app allows you to use your smart phone to browse our complete range of products, add products to your Favourites or to the Quote Basket and allows you to email the contents of the basket back to yourself.

With Scolmore®, OVIA® Lighting, ESP® & UNICRIMP® products available you can use the search facility to easily locate the products required.

Our App also has a useful tool kit featuring:

Quick Quote Calculator, Zs Values, Cables Selection & Voltage Drop, Adiabatic Equation Calculator, Power Factor Calculator, KVA Converter, Lighting Cost Saving Calculator, Lighting No. Calculator and many more...



ESP® Marketing Hub

The Marketing Hub gives customers the opportunity to enhance their own marketing facilities with very little effort or cost. A selection of templates are available featuring many of our popular products. These templates can be customised with our stockists' details to provide maximum impact and optimise local sales opportunities.

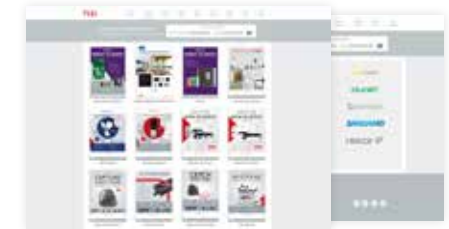

Print Ready Leaflets & More!

Promotional leaflets are available to download for both ESP® and Sangamo. They have editable sections so you can add your companies details. Also download all of our product images, all saved by product code and at a perfect resolution for your website.

espuk.com/marketing

Call: 01527 515150

A comprehensive range of cable accessories...



UNICRIMP®

Established as a new business by the Scolmore® Group in 2015, Unicrimp® brings to the electrical contracting industry a comprehensive range of cable accessory products.

All products within the Qcrimp® range are manufactured under stringent quality control systems and are fully compliant with the very latest industry regulations.

Available exclusively through the electrical wholesale trade and marketed under Q-Crimp, the range includes cable ties, crimp terminals, PVC tape, copper tube terminals, cable clips, and brass and nylon glands. In addition, the Q-Fire range of fire-rated products provides installers with solutions that will help satisfy the latest IET wiring Regulations. Providing everything required to harness cable between the consumer unit and the end accessory.

Aligned with the core values of the Scolmore® Group of companies, Unicrimp® offers the same levels of outstanding customer service, high quality products and commitment to new product development.

Situated close to the Group Headquarters in the Midlands, the Unicrimp® distribution centre is ideally located to supply to all areas of the UK.

Q-Crimp

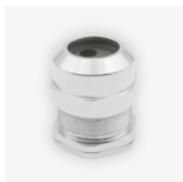

OB1



Q-Fire



Q-Nect



Cable Clips

Our range of easy install, self-gripping Cable Clips for keeping cabling neat & tidy.



PVC Tape

General purpose non migratory plasticised insulation tape supplied in lengths of 20M and 33M with all colours as detailed.



Nylon & Brass Cable Glands

IP68 nylon glands are available in various sizes from 12mm to 32mm in black, grey, white and red. BW, CW, AE1W & CXT Cable Glands are manufactured to the latest approvals and BS 6121.



Cable Ties

Nylon and stainless steel cable ties available in a range of sizes and made to the highest of quality.



Cable Ties Accessories

Eyelets, cradles, 2-way cable tie bases, mounts, earth sleeving.



Plugs & Sleeving

Masonry fixings for cable ties. PVC sleeving & PVC heat shrink sleeving.

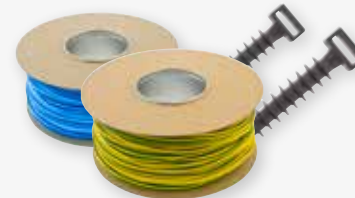

Copper Tube & Pre-Insulated Terminals

Uninsulated copper tube terminals are available in a range of sizes with bell mouth cable entry. Pre-insulated crimp terminals carry UL approval and are designed to improve electrical and mechanical integrity with heavy duty use.



www.unicrimp.com

Fixings

Wall plugs; fixings, bolts, screws, toggles, nuts and washers.



Email: contractor@scolmore.com

Grommets & Cleats

Quick fit grommets, standard grommets, earth clamps. Available in a range of colours & sizes.



Call: 01827 300600

OB1

THE NO.1 SEALANT & ADHESIVE

The original multi-surface construction sealant & adhesive from Unicrimp®



Fire Safe Metal Cable Clips

- Long nail for good pull out value
- Thick steel nail prevents snapping
- Stress crack resistant
- High grade steel construction for high temperature fire rated installations



Saddle Bar Spacers

- Fast and easy to use
- Metal Construction
- Permanent, secure connections
- Suitable for conduit from 20mm - 25mm
- Fire Resistant



Expanding Foam

Single component, flame resistant, B1 quality construction foam which cures by air moisture. It expands up to 30 times its original volume and is quick drying. Flame resistant only in between solid mineral or metal construction materials - gap depth and width a maximum of 40mm.



Saddle Clips & P-Clips

- Assist installation of fire cable to meet the requirement of BS 5839-1: 2017
- Tested & approved to BS 476 Pt.6 and BS 476 Pt.7



Stainless Steel Mounts & Fire Safe Cable Clips

- Cable tie width of 10mm (maximum)
- Fixing hole M5 and M6 options
- Made from 316 grade steel
- Clips available in 25mm

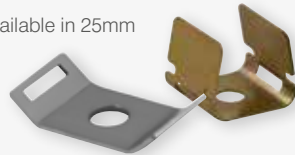

All-Round Banding

Available in 12mm or 17mm. Black, red, white and galvanised.



Stainless Steel Cable Ties

- Minimum loop tensile strength 4.6mm wide = 44kg
- Minimum loop tensile strength 7.9mm wide = 110kg
- Made from 316 grade steel.

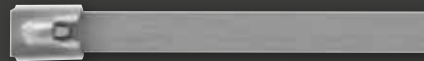

2, 3 & 5 Way Lever Connectors

Suitable for solid, stranded and flexible cable types, the lever operated connectors use screwless spring clamp technology, which means there is no need for any tools.



2 & 3 Way IP Connection Boxes

- Hinged lid for easy access
- Wall mountable
- Pre-fitted nylon glands
- IP68 4 pole connection box
- IP68 3 pole connection box



IP66 Weatherproof Junction Box

The IP Box can house 4 x 3 Port Lever Connectors using the 360° detachable cradle. The IP Box also utilises a curved lid which provides additional space for wires, the lid is locked using 1/4 turn fasteners.



*Available in black or grey.

5 Pole, 3 Way IP68 'T' & Inline Connectors

- Tough nylon body
- 5 pole terminal
- IP68 'T' connector
- IP68 inline connector
- Perfect for multiple installations



UNICRIMP® Website

The refreshed new site provides customers with access to detailed product information for the company's extensive Q-Crimp® branded range of cable management consumables, which includes cable ties, crimp terminals, PVC tape, copper tube terminals, cable clips and nylon cable glands.

With regular updates on new products and details of developments within our business, the site is a great source of information.

Online Ordering

The site now incorporates a number of improved features that allow users to access new information directly and easily:

- Ordering 24 hours a day 7 days a week with the ability to check current stock levels as required, meaning you are not restricted to ordering during normal office hours.
- Access to on-line catalogues will keep you fully updated with the complete product range and provide information on new products as and when they become available.
- The order tracking service keeps you up to date with the progress of your shipment.
- Managing your administration paperwork is now even easier with instant access to reports and essential documents at a click of a button.
- A 'quick buy tab' and the ability to store the most common orders for repeated use, adds to the versatility and flexibility of the revised system.
- PDF purchase order uploads now available. You can now take your purchase order directly in PDF format and upload it to automatically extract the data and validate its contents.

www.unicrimp.com

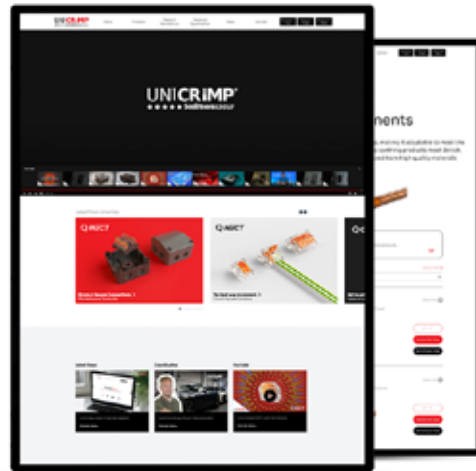

The Full Q-Crimp® Range

The full product range can be found online with specific information about each product and access to the latest Unicrimp® catalogue.



To Register: E-mail us at sales@unicrimp.com or call our Sales Office on **01827 300 600** and one of our Sales Representatives will be more than happy to get you on-line.

Email: contractor@scolmore.com

Scolmore® Group App

The Scolmore® Group app allows you to use your smart phone to browse our complete range of products, add products to your Favourites or to the Quote Basket and allows you to email the contents of the basket back to yourself.

With Scolmore®, OVIA® Lighting, ESP® & UNICRIMP® products available you can use the search facility to easily locate the products required.

Our App also has a useful tool kit featuring:

Quick Quote Calculator, Zs Values, Cables Selection & Voltage Drop, Adiabatic Equation Calculator, Power Factor Calculator, KVA Converter, Lighting Cost Saving Calculator, Lighting No. Calculator and many more...



Marketing Hub

The Marketing Hub gives customers the opportunity to enhance their own marketing facilities with very little effort or cost. A selection of templates are available featuring many of our popular products. These templates can be customised with our stockists' details to provide maximum impact and optimise local sales opportunities.



Print Ready Leaflets & More!

Promotional leaflets are available to download for UNICRIMP®. They all have editable sections so you can add your companies details. Also download all of our product images, all saved by product code and at a perfect resolution for your website.

unicrimp.com/marketing-hub

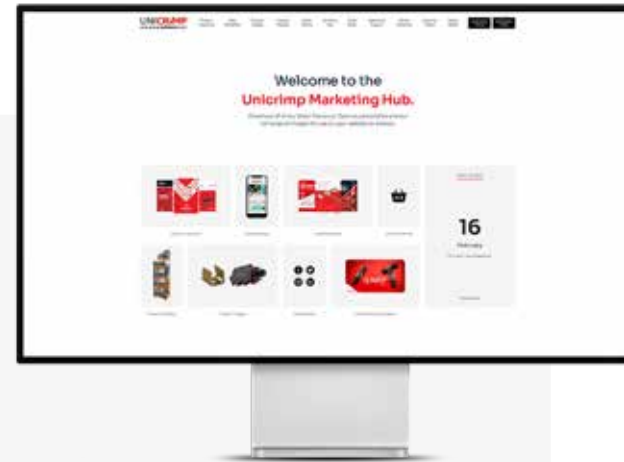

Call: 01827 300600



CPD Training

Our training is designed to support all of our customers at whatever level of expertise they require. Our professional in-house trainers pride themselves on their industry knowledge and best practice applications of our all-encompassing product portfolio. Whether it's complex emergency lighting solutions or earth rod selection, our team of experts are here to assist and broaden your knowledge.

By having the products on hand, attendees are able to receive full hands-on training allowing them to fully experience the products and applications of each product.



Southern Ireland

click Litehouse

18 Corrig Road,
Sandyford Industrial Estate,
Dublin, D18 WV79, Ireland

T: +353 (1) 2811 122
F: +353 (1) 2811 224
E: sales@clicklitehouse.ie

www.clicklitehouse.ie

Dubai UAE

scolmore DUBAI

Lake Central Tower,
Office 1803, Business Bay,
Dubai, UAE

UAE Office: +971 4589 6552
Mob: +971 52 451 1164
E: sales@scolmoredubai.com

www.scolmoredubai.com

United Kingdom

click Scolmoregroup

Scolmore House, Mariner,
Lichfield Road Industrial Est,
Tamworth, Staffordshire,
B79 7UL, United Kingdom

T: +44 (0)1827 63454
F: +44 (0)1827 63362
E: sales@scolmore.com

www.scolmore.com

United Kingdom

OVIA Scolmoregroup

Scolmore House, Mariner,
Lichfield Road Industrial Est,
Tamworth, Staffordshire,
B79 7UL, United Kingdom

T: +44 (0)1827 300640
E: sales@oviaUK.com

www.oviaUK.com

United Kingdom

ESP Scolmoregroup

Unit 7, Target Park,
Shawbank Road,
Lakeside, Redditch,
B98 8YN, United Kingdom

T: +44 (0)1527 515150
F: +44 (0)1527 515143
E: sales@espuK.com

www.espuK.com

United Kingdom

UNICRIMP Scolmoregroup

Scolmore House, Mariner,
Lichfield Road Industrial Est,
Tamworth, Staffordshire,
B79 7UL, United Kingdom

T: +44 (0)1827 300 600
F: +44 (0)1827 300 620
E: sales@unicrimp.com

www.unicrimp.com