

Technical Specification

Product Code: OV6406

Description: 6W 140mm Diameter Adaptable Downlight With CTA Switch - White

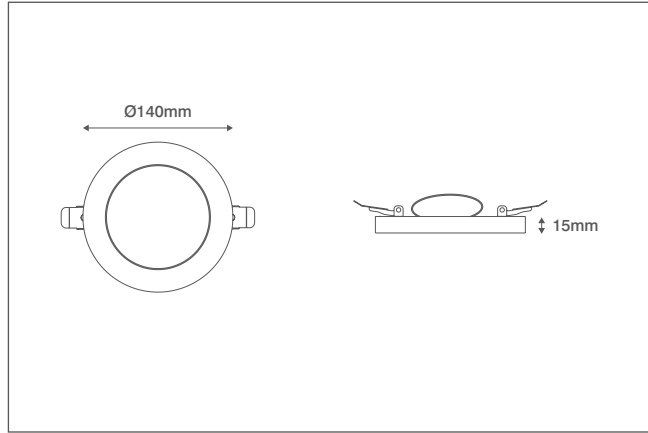

General Information

Dimensions	140mm Diameter x 15mm (D)
Materials	Body: Polycarbonate Diffuser: Polystyrene
Finish	White (RAL 9016)
Product Weight	0.208Kg
Cutout (If Available)	55-100mm Diameter
Ingress Protection	IP20
Warranty	3 Years

Supply & Power

Input Voltage & Frequency	240V~ 50/60Hz
Electrical Safety	Class II (Double Insulated)
Input Power	6W
Input Current	50mA
In-rush Current	1A (10ms)
Power Factor	>0.5
Ambient Temperature (Ta)	-20°C - +40°C
Critical Temperature	+50°C
LED Driver	Integrated
Input Mains Cable	2 x 0.75mm ² H03-VH2F (180mm)

Luminaire Output

Colour Temperature	3000K	4000K	6000K
Typical Luminous Flux	409lm	453lm	425lm
Efficacy	68lm/W	76lm/W	71lm/W
CRI	>80		
Beam Angle	110°		
Flicker Free	Yes		
LED Lifetime (L70)	30,000 Hours		

Accessories

OVBZ646SC	Fascia Ring For 6W Downlight - Satin Chrome
OVBZ646CH	Fascia Ring For 6W Downlight - Chrome
OVBZ646BK	Fascia Ring For 6W Downlight - Black

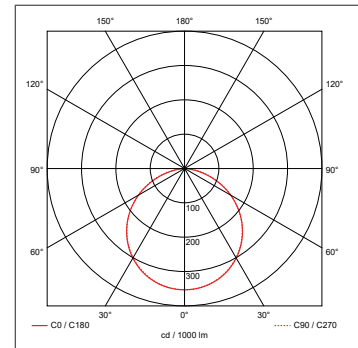

3000K

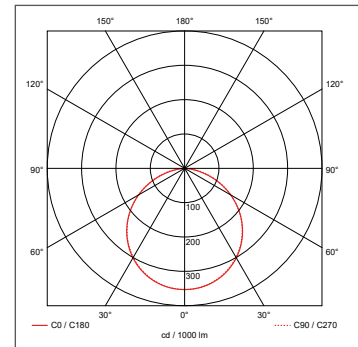

4000K

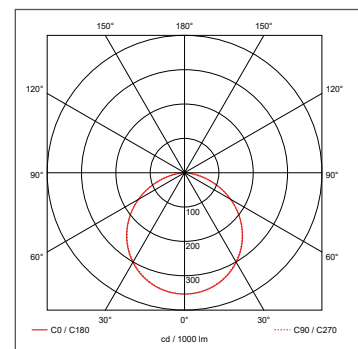

6000K

